



## A Full Line Up of Powerful Servos to Meet the Demands of Your Application!

Compumotor began manufacturing brushless servo motors with the release of the SM series in the spring of 1995. Since that time, we have continued to expand our product offering and have manufacturing plants in California and Italy.

### Innovation in Design

Compumotor utilizes two distinct technologies in the manufacturing of brushless servo motors. The Slotless Design and the Bridged Stator Design both reduce motor manufacturing costs while providing performance advantages to the user.

The slotless design eliminates all detent torque in the motor, providing superior performance in applications requiring smooth, low speed operation. This design also results in higher rotor inertia, providing an advantage in applications involving high inertia loads.

The bridged stator design results in extremely high torque-to-

inertia ratios, providing a performance advantage in applications requiring high accelerations. The bridged stator design also greatly reduces detent torque and mechanical noise when compared to a conventional slotted motor.

Compumotor can also provide an integrated planetary gearhead for use with our brushless servo motors. Our unique design integrates the pinion of the gearhead into the motor shaft, reducing total package length by almost two inches.

### Standards or Specials in 10 Days

Compumotor's brushless servo motors are manufactured in our modern JIT manufacturing facility. Highly evolved manufacturing philosophies provide levels of service and product availability previously unattainable in the servo motor industry.

Compumotor's lead times average less than ten days for all standard and custom servo motors.

#### SM Series



- Size 16 and 23
- 0.8 to 11.3 in-lb. continuous torque
- Slotless design
- Rugged housing (IP65 option)
- Connection options

#### SE Series



- Size 16 and 23
- 0.8 to 10.1 in-lb. continuous torque
- Slotless design
- Plastic encoder cover
- Short package length

#### BE Series



- Size 16, 23 and 34
- 1.4 to 46 in-lb. continuous torque
- Bridged stator design
- 2000-line encoder standard
- Connection options

#### M Series



- Size 105, 145 and 205mm
- Up to 90 Nm of power
- Brushless construction
- Encoder feedback and resolver

#### Planetary Gearheads



- Size 16, 23, 34 and 92
- Integrated pinion design
- Shortest package length available

#### NeoMetric & J Series



- 70 mm and 92 mm
- 6 to 61 in-lb. continuous torque
- Bridged stator design
- Rugged housing (IP65 option)
- Connection options

#### SL Series



- Size 42, 63, 102 and 140mm
- 20 to 350 lbs continuous force
- Slotless design
- High speeds
- High precision

## Custom Designed Servo Motors for Your Specific Application!

Compumotor offers a broad range of standard options with all of our brushless servo motor families. Our numerous shaft, feedback and connection options will fulfill the needs of most of our customers. However, we realize that from time to time the need arises to have a custom motor designed specially for your application.

Whether you need custom connectors, mounting, or a custom winding, Compumotor can build a motor designed to your exact specifications. Compumotor provides these special designs for our customers with:

- Minimal impact on product lead time
- Modest impact on pricing
- No minimum quantities

Compumotor's modern manufacturing system allows us to offer custom motor solutions without sacrificing product quality and availability. All of our custom motors are built in our standard servo motor work cell, and our computerized custom product tracking system allows us to provide consistent, high-quality custom products. And, because custom motor manufacturing is integrated into our standard manufacturing process, we can often build and ship custom designed motors and cables in the same time frame as standard products.

Compumotor provides this service for one simple reason: to make it easier for you, our customer, to integrate a Compumotor servo motor into your application. We provide more than just a component, we provide a custom designed servo motor solution.

### Common Special Requests

#### Connectorization

- Right angle connector housing
- MS connectors on back cover
- Special cable lengths
- Hi-flex cables
- Customer specified cables and connectors
- Cable exiting through back cover

#### Flanges

- Tapped mounting holes
- Customer specified flanges
- Face mount

#### Gearheads

- Non-standard ratios
- Customer specified flanges
- Customer specified output shaft

#### Windings:

- Specific bus voltage

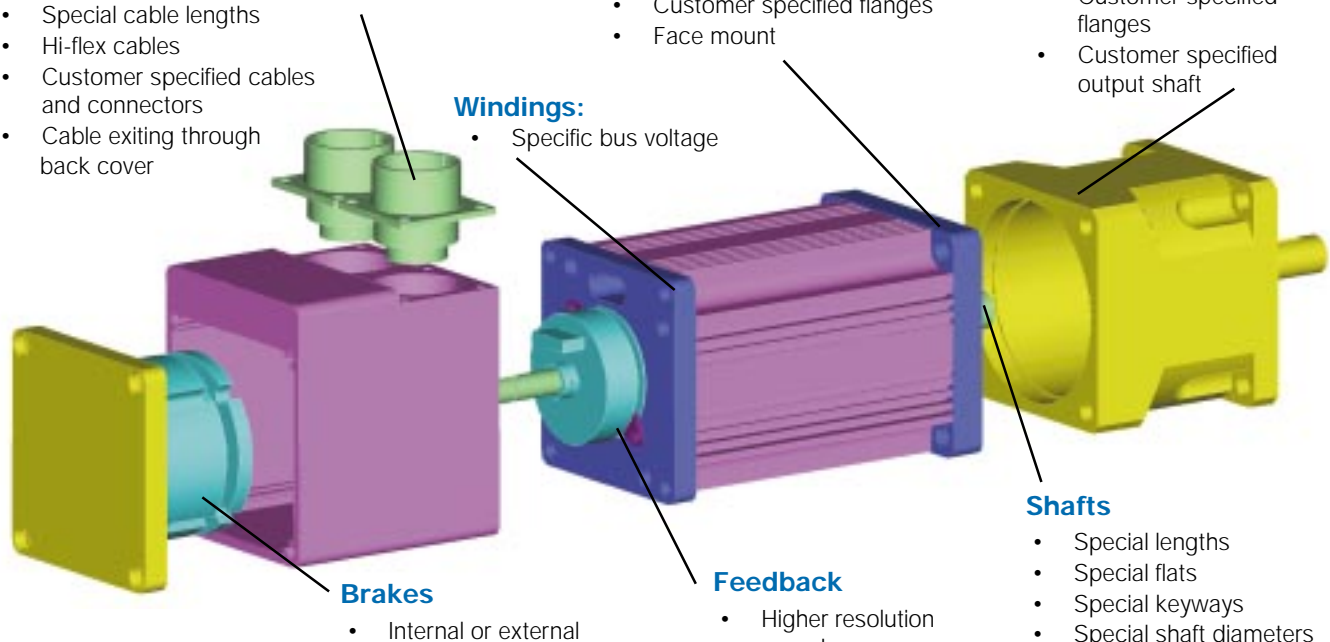

#### Brakes

- Internal or external

#### Feedback

- Higher resolution encoders
- Higher temperature encoders

#### Shafts

- Special lengths
- Special flats
- Special keyways
- Special shaft diameters
- Metric shaft diameters
- Hollow shafts
- Rear Shaft Extension
- Double flats
- Shaft pinning
- Pressed on gears
- Center tapped
- Special shaft materials

#### Miscellaneous Options

- Private label back cover
- Special windings
- Shorter lengths
- High speed balancing
- Special finish



Custom Designed Servo Motors For Your Specific Application. Call 1-800-358-9070 Today.

# M Series Motors



## Low Cost, High Performance

The M Series is Compumotor's newest series of motors. Completing Compumotor's line of servos, the M Series moves innovative design into larger-frame motors, yet they remain affordably priced. An eight-pole design allows for highly dynamic motion while minimizing power loss within the motor itself.

### Features

- Size 105, 145 and 205mm diameters
- 53 to 115 lb-in continuous torque
- Brushless construction
- Thermal protection
- IP65 option
- Resolver and encoder feedback options
- Two-year warranty
- CAD (.dxf) drawings available
- CE compliant
- Electrically released brakes available

### Part Numbering System

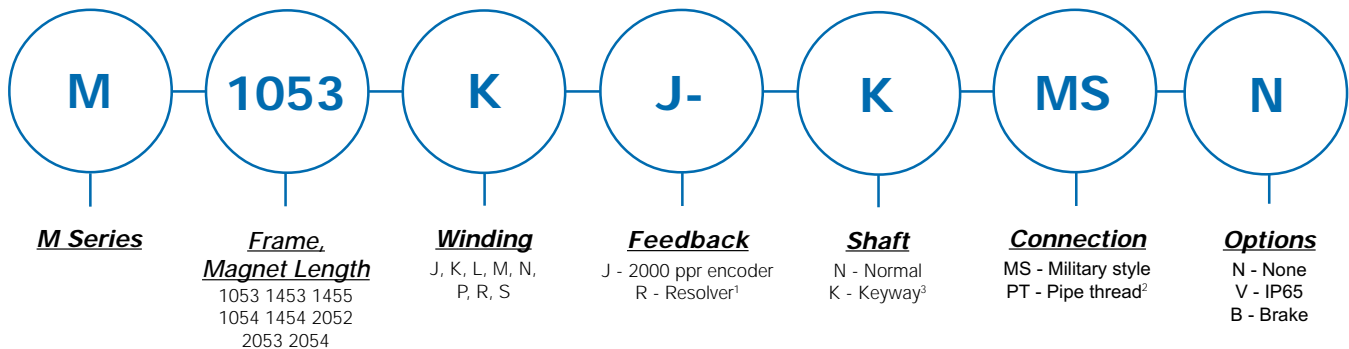

<sup>1</sup> Standard resolver not compatible w/ APEX drives. Please contact Compumotor's Custom Servo Motor group for motors compatible with the APEX series of drives

<sup>2</sup> Pipe thread only available in M2053 and M2054 resolver motors

<sup>3</sup> Standard

Custom Designed Servo Motors For Your Specific Application. Call 1-800-358-9070 Today.

105mm, 145mm & 205mm Encoder & Resolver Feedback Specifications

Parameter	Symbol	Units	M1053K	M1054K	M1453L	M1454N	M1455P	M2052P	M2053R	M2054S
Stall Torque Cont [1]	Tcs	oz-in	1171.2	1438.8	3867.9	5290.6	6454.1	9938.4	13871.77	17842.30
Stall Torque Cont [1]	Tcs	lb-in	73.2	90.0	241.7	330.6	403.4	621.2	867.0	1115.1
Stall Torque Cont [1]	Tcs	Nm	8.3	10.2	27.3	37.4	45.6	70.2	97.96	126.00
Stall Current Cont [1,4,8]	Ics(sine)	Amps peak	20.32	23.70	40.70	55.67	63.64	60.94	85.05	109.40
Stall Current Cont [1]	Ics(RMS)	Amps RMS	14.37	16.76	28.78	39.36	45.00	43.09	60.14	77.36
Peak Torque [6]	Tpk	oz-in	3513.6	4316.4	11603.7	15871.7	19362.3	29815.3	41615.32	53526.90
Peak Torque	Tpk	lb-in	219.6	269.8	725.2	992.0	1210.1	1863.5	2601.0	3345.4
Peak Torque [6]	Tpk	Nm	24.9	30.6	82.3	112.5	137.3	211.4	293.8	377.9
Peak Current [4,6,8]	Ipk(sine)	Amps Peak	61.0	71.1	122.1	167.0	190.9	182.8	255.16	328.20
Peak Current [6]	Ipk(RMS)	Amps RMS	43.1	50.3	86.3	118.1	135.0	129.3	180.43	232.07
Rated Speed [2]	Wr	rpm	5000	5000	3000	3000	3000	1700	3000	3000
Current @ Rated Speed	I <sub>r</sub> (sine)	Amps Peak	17.82	18.34	39.11	52.70	59.10	58.77	76.72	97.07
Current @ Rated Speed	I <sub>r</sub> (RMS)	Amps RMS	12.60	12.97	27.65	37.27	41.79	41.56	54.25	68.64
Torque @ Rated Speed	Tr	oz-in	1011	1091.7	3700	4980	5960	9526	12425.39	15717.20
Torque @ Rated Speed	Tr	Nm	7.14	7.71	26.13	35.17	42.09	67.27	87.75	111.00
Shaft Power @ Rated Speed	Po	watts	3739	4037	8210	11050	13225	11978	27571.14	34875.44
Voltage Constant [3,4]	Kb	volts/rad/s	0.4700	0.4950	0.7750	0.7750	0.8270	1.3300	1.33	1.33
Voltage Constant [3,4]	Ke	volts/Krpm	49.22	51.84	81.16	81.16	86.60	139.28	139.28	139.28
Torque Constant [3,9]	Kt(sine)	oz-in/ Amps Peak	57.64	60.70	95.04	95.04	101.41	163.10	163.10	163.10
Torque Constant [3,4]	Kt(trap)	oz-in/ Amps DC	66.55	70.09	109.74	109.74	117.10	188.33	188.33	188.33
Torque Constant [3]	Kt(RMS)	oz-in/ Amps RMS	81.51	85.84	134.40	134.40	143.42	230.65	230.65	230.65
Resistance [3]	R	Ohms	0.48	0.36	0.22	0.12	0.097	0.170	0.10	0.10
Inductance [5]	L	mH	2.03	1.67	1.94	1.05	0.79	1.90	1.59	1.27
Max Bus Voltage	Vm	Volts DC	560	560	560	560	560	560	560	560
Thermal Resistance Wind-Amb	Rth w-a	C/watt	0.50	0.49	0.28	0.26	0.252	0.157	0.137	0.118
Motor Constant	Km	oz-in/ sqrt(watt)	96.06	116.82	236.12	312.90	375.80	456.76	595.55	711.81
Viscous Damping	B	oz-in/Krpm	2.4	4.5	3.0	6.3	7.3	17.0	21.0	28
Static Friction	Tf	oz-in	4.0	6.0	7.0	10.0	12.0	21.0	23.5	30
Elect Time Constant	Tau_elec	millsecs	4.23	4.64	8.98	8.54	8.17	11.24	15.90	18.14
Mech Time Constant	Tau_mch	millsecs	1.0	0.9	0.6	0.4	0.4	0.8	0.6	0.4
Rotor Inertia	J	lb-in-sec <sup>2</sup>	4.2E-03	5.5E-03	1.4E-02	1.9E-02	2.4E-02	7.1E-02	9.7E-02	9.70E-02
Rotor Inertia	J	kgm <sup>2</sup>	4.8E-04	6.2E-04	1.6E-03	2.2E-03	2.7E-03	8.0E-03	1.1E-02	1.10E-02
Rated Winding Temp	WTr	C	125	125	125	125	125	125	125	125
Rated Ambient Temp	Tamb	C	20	20	20	20	20	20	20	20
Rated Case Temp	Tcase	C	106	106	106	89	100	98	98	98
Number of Poles	Np		8	8	8	8	8	8	8	8
Weight	#	lbs	19	22.9	30.80	39.60	48.00	97.00	130	162
Winding Class			H	H	H	H	H	H	H	H

1 @ 40° C ambient, derate phase currents and torques by 7%.  
 2 For higher-speed operation, please call the factory.  
 3 Measured line to line, +/- 10%.  
 4 Value is measured peak of sine wave.  
 5 +/- 30%, line to line, inductance bridge measurement @ 1Khz.  
 6 Initial winding temperature must be 60° C or less before peak current is applied.

7 Direct current through a pair of motor phases of a trapezoidally (six state) commutated motor.  
 8 Peak of sinusoidal current in any phase for a sinusoidally commutated motor.  
 9 Total motor torque per peak of the sinusoidal amps measured in any phase, +/- 10%.  
 10 Maximum time duration with 2 times (or 3 times) rated current applied with initial winding temperature at 60° C.

# M Series Performance Curves

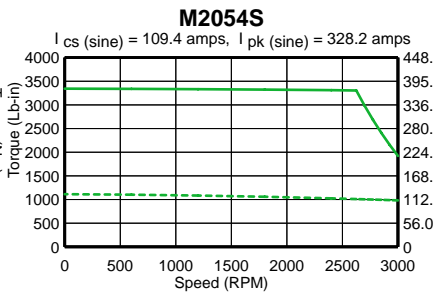
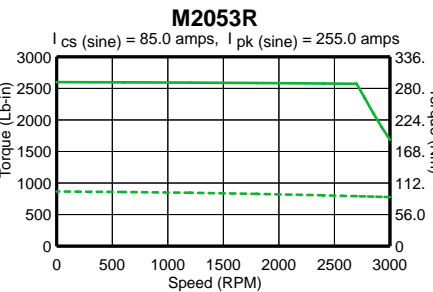
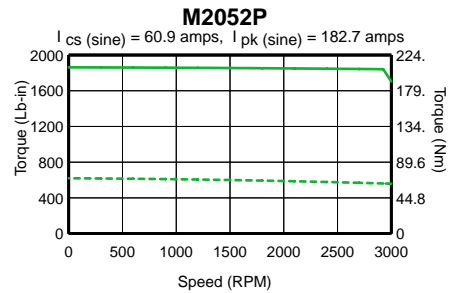
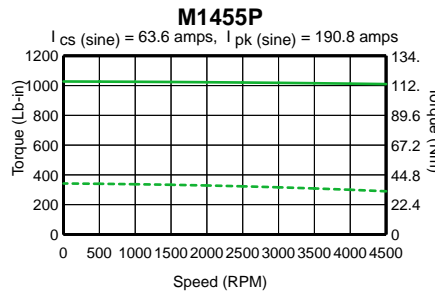
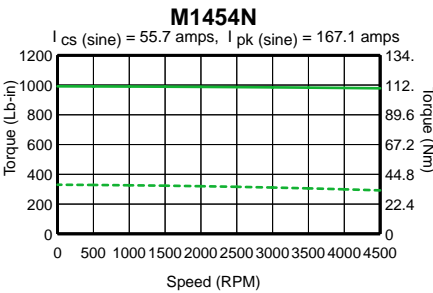
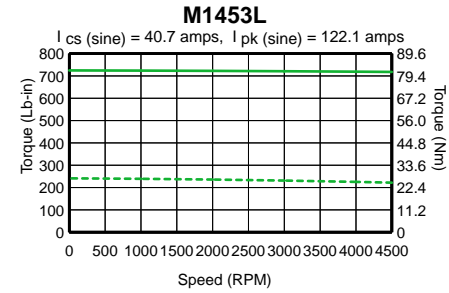
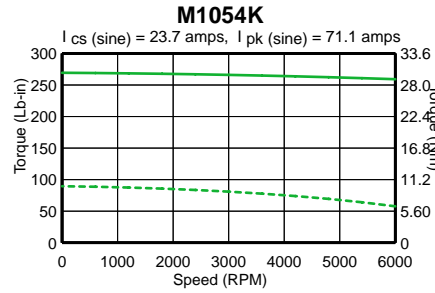
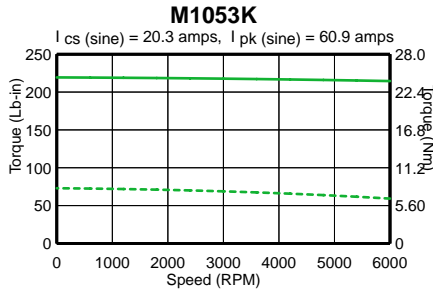

--- CONTINUOUS    — PEAK  
(560VDC)

Custom Designed Servo Motors For Your Specific Application. Call 1-800-358-9070 Today.

# M Series Dimensional Drawings

Dimensions in inches (mm)

## 105 mm Dimensional Drawing

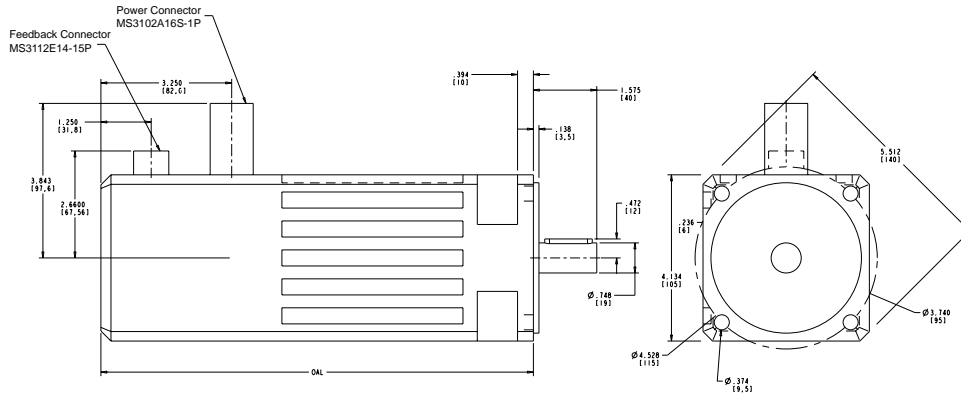

## 145 mm Dimensional Drawing

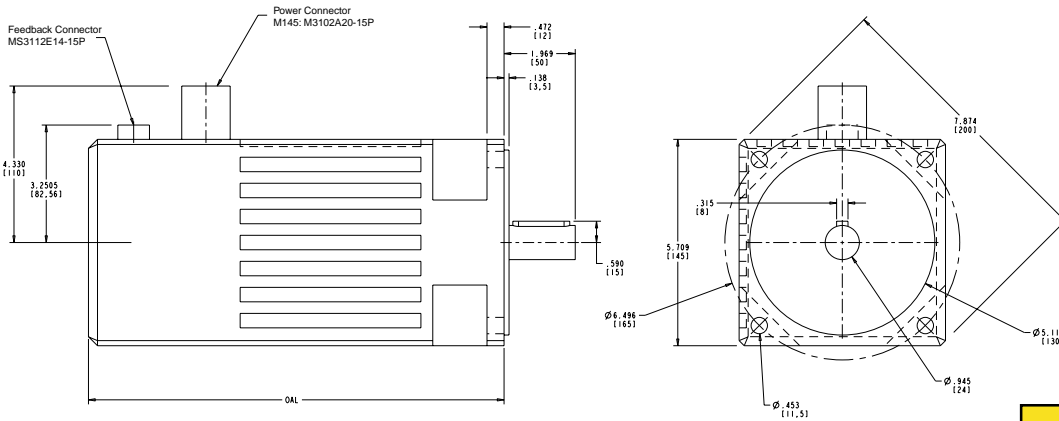

## 205 mm Dimensional Drawing

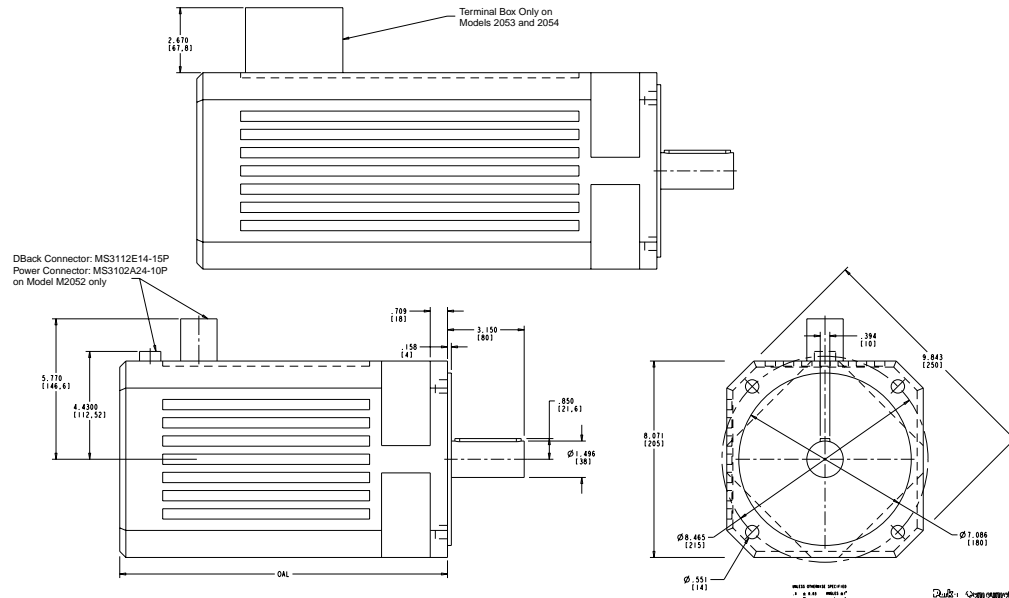

### Motor Sizes

Model	Motor Length
M1053	10.75 (273.0)
M1054	12.48 (317.0)
M1453	11.50 (292.0)
M1454	13.94 (354.0)
M1455	16.38 (416.0)
M2052-MS	13.46 (342.0)
M2053-PT	16.18 (411.0)
M2054-PT	18.90 (480.1)

# Wiring and Cable Specifications

## “MS” Connection Options

The M Series Motors are available standard with “MS” connectors. These bayonet-style connectors provide quick-disconnect. Mating cables are specified and ordered separately. With the “MS” connection option, the motor phase and brake wires are in one connector, and the hall, encoder, and temperature switch wires are in the other connector. This option works well when using an amplifier with a built-in controller, or when all cables enter into a cabinet or enclosure and then are wired into a terminal strip.

## “PT” Connection Options

The M2053 and M2054 motors with resolver feedback are available with the PT connector option due to the high current requirements of these motors. A terminal block is available inside the motor housing to make the required connections.

### Motor Connection

Designation	Pin Number	Wire Color
Phase A	A	Black #1
Phase B	B	Black #2
Phase C	C	Black #3
Ground	D/E	Green/Yellow
Shield	Shell	Clear
Brake	F	Red/Blue
Brake	G	Red/Blue

### Encoder Connection

Designation	Pin Number	Wire Color
CH A +	C	White
CH A -	D	Yellow
CH B +	A	Green
CH B -	B	Blue
CH Z +	E	Orange
CH Z -	F	Brown
Hall 1	H	White/Brown
Hall 2	J	White/Orange
Hall 3	G	White/Violet
+5V	K	Red
0V	L	Black
Temp	M	Yellow/Orange
Shield	N	Shield
Temp	R	Yellow/Orange

### Resolver Connection

Designation	Pin Number	Wire Color
SIN +	A	Green
SIN -	B	Blue
COS +	D	Black
COS -	E	Red
EXC +	G	Brown
EXC -	H	White
Temp	K	Yellow/Orange
Temp	L	Yellow/Orange
Drain	M	

Custom Designed Servo Motors For Your Specific Application. Call 1-800-358-9070 Today.

# M Series, Feedback Specifications

## Encoder Specifications

### Mechanical

Accuracy	±2 min of arc
Input power	5 VDC ±5%, 135 mA
Operating frequency	300 kHz max
Output device	26LS31
Sink/Source, nominal	20 mA

### Electrical

## Hall-Effect Specifications

### Electrical

Input power	5 VDC ±5%, 80 mA
Output device	LM2901
open collector	
Maximum pull up	12 VDC
Sink	16 mA

## Resolver Specifications

### Parameter

### Value

Input voltage @ 7 kHz	4.25 volts
Input current, max	55 mA
Input power, nominal	0.12 watts
Impedance ZSO (@ 90°)	58+j145 ohms
Impedance ZRO	53+j72 ohms
Impedance ZRS	42+j55 ohms
Transformation ratio	0.470 ±5%
Output voltage	2.0 ±5% volts
DC rotor resistance	23 ±10% ohms
DC stator resistance	19 ±10% ohms
Sensitivity	35 mV/degree
Max error from EZ	±10 minutes
Phase shift, open circuit	5° leading, ±3" of arc
Null voltage, total	20 mV rms
Impedance ZSS	50+j128 ohms
Inertia	Incl. with motor spec.

## Commutation Chart

Clockwise rotation as viewed from front shaft.

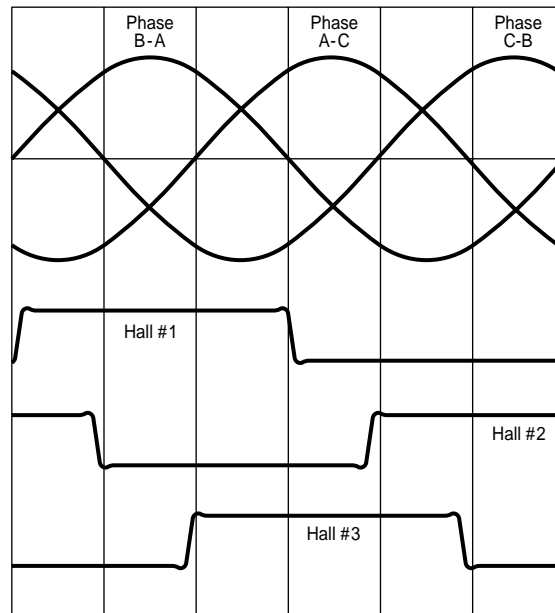

## Brakes

Type	Units	105mm	145mm	205mm
Supply voltage	vdc	24	24	24
Current @ 20C	amps	1.1	1.8	1.65
Resistance @ 20C	ohms	22	13.2	14.5
Max static torque	Nm	10	30	100
Max static torque	in-lb	89.2	267.6	892
Moment of inertia	kgm <sup>2</sup> 10E-3	0.0625	0.195	1
Moment of inertia	lb-in-sec <sup>2</sup> 10E-3	0.553125	1.72575	8.85