



## High-Torque Design, Compact Package

Parker's SMN series of rotary servo motors combines a high-performance segmented stator design with competitive pricing for today's demanding servo applications. The modern eight-pole segmented stator architecture produces extremely high torque values for a given motor volume. The SMN motor family is offered in frame sizes ranging from 60 mm to 142 mm and is available with resolver, quadrature encoder or high-resolution SinCos feedback devices.

### SMN Motor Features

- High performance per dollar
- High torque density package
- 1.4 – 14.5 N-m continuous torque range
- Brushless construction
- Resolver, encoder or SinCos (absolute) feedback
- Five frame sizes from 60 mm to 142 mm
- IP64 standard
- IP65 option

### Motor Part Numbering System

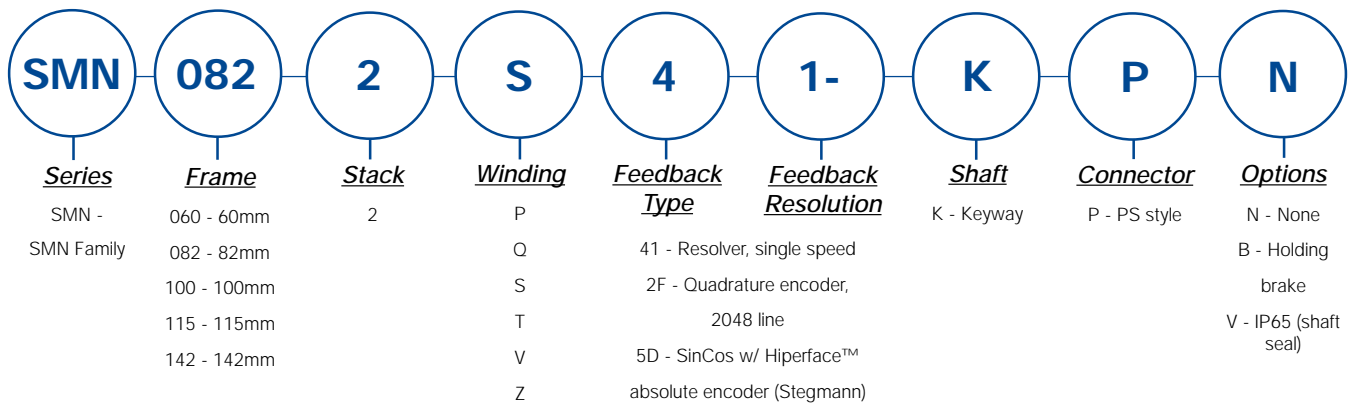

Custom Designed Servo Motors For Your Specific Application. Call 1-800-358-9070 Today.

Motor Speed-Torque Performance Curves

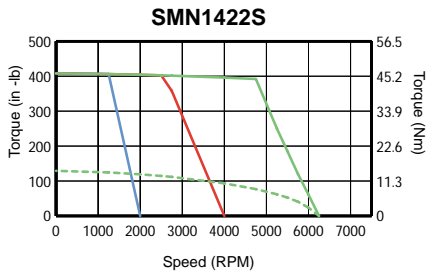
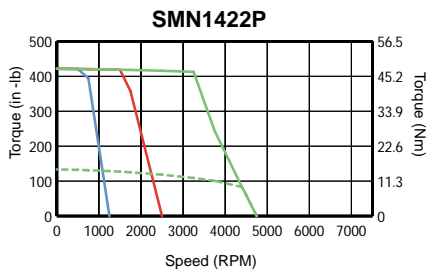
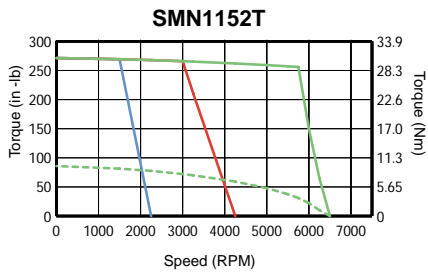
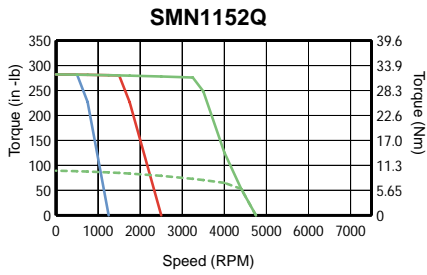
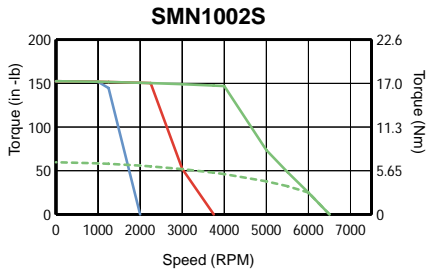
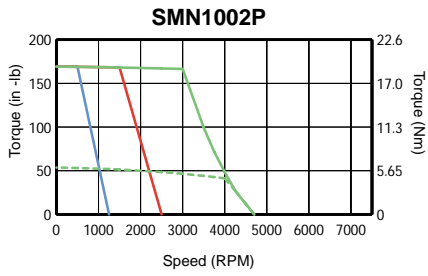
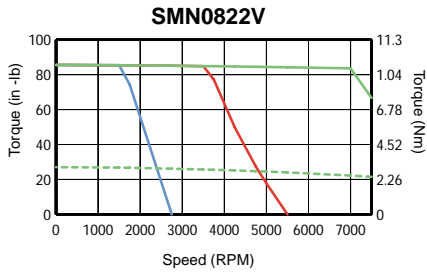
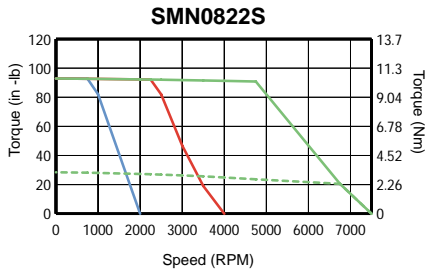
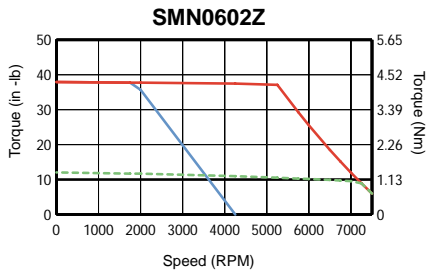
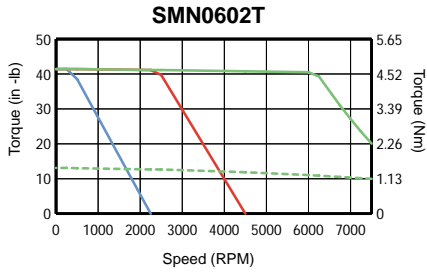

— Peak (120V)    
 — Peak (240V)    
 — Peak (460V)    
 - - - - - Continuous

SMN Technical Specifications

Parameter	Symbol	Units	SMN0602T	SMN0602Z	SMN0822S	SMN0822V	SMN1002P	SMN1002S	SMN1152Q	SMN1152T	SMN1422P	SMN1422S
Stall Torque Cont [1]	Tcs	lb-in	13.01	11.95	28.41	26.99	53.36	59.38	83.96	84.91	128.72	124.60
Stall Torque Cont [1]	Tcs	Nm	1.47	1.35	3.21	3.05	6.03	6.71	9.49	9.59	14.54	14.08
Stall Current Cont [1]	Ics(RMS)	Amps RMS	1.82	2.88	3.34	4.47	3.77	6.57	5.72	10.86	9.44	15.05
Peak Torque	Tpk	lb-in	41.06	37.70	92.21	84.96	167.96	151.50	268.48	267.48	405.47	392.50
Peak Torque [6]	Tpk	Nm	4.64	4.26	10.42	9.60	18.98	17.12	30.36	30.22	45.81	44.35
Peak Current [6]	Ipk(RMS)	Amps RMS	5.73	9.08	10.84	14.07	11.86	16.75	18.3	34.2	29.7	47.4
Rated Speed [2]	Wr	rpm	6000	6000	6000	6000	3000	4000	4200	5000	4400	5000
Current@ Rated Speed	Ir(RMS)	Amps RMS	1.47	2.32	2.63	3.52	3.34	5.40	4.89	8.77	8.15	12.51
Torque@ Rated Speed	Tr	lb-in	9.82	8.94	21.24	20.09	46.37	47.70	70.55	67.09	109.58	101.85
Torque@ Rated Speed	Tr	Nm	1.11	1.01	2.40	2.27	5.24	5.39	7.97	7.58	12.38	11.51
Shaft Power @ Rated Speed	Po	watts	698	635	1508	1427	1647	2258	3507	3970	5706	6027
Voltage Const [3,4]	Kb	volts/rad/s	0.6619	0.3833	0.7849	0.5572	1.3067	0.8344	1.36	0.72	1.26	0.76
Voltage Const [3,4]	Ke	volts/Krpm	69.31	40.13	82.19	58.35	136.84	87.38	100.32	75.53	131.81	79.97
Torque Const [3]	Kt(RMS)	lb-in/ Amps RMS	7.17	4.16	8.50	6.02	14.16	9.03	14.68	7.82	13.64	8.28
Resistance [3]	R	Ohms	12.8	5.1	4.3	2.4	3.6	1.2	2.4	0.7	1.1	0.4
Inductance [5]	L	mH	32.3	10.6	24.6	11.7	33.5	15.7	19.00	4.78	10.70	4.50
Max Bus Voltage	Vm	Volts DC	680	340	680	680	680	680	680	680	680	680
Thermal Resistance Wind-Amb	Rth w-a	C/watt	1.13	1.13	1.00	1.00	0.94	0.94	0.61	0.61	0.48	0.48
Motor Constant	Km	oz-in/ sqrt(watt)	26.20	24.03	53.60	50.93	97.66	108.77	123.83	125.24	168.41	163.02
Viscous Damping	B	oz-in/Krpm	0.8	0.8	1.9	1.9	2.3	2.3	2.5	2.5	3.0	3.0
Static Friction	Tf	oz-in	6.0	6.0	7.5	7.5	9.0	9.0	10.5	10.5	12.0	12.0
Elect Time Constant	Tau_elec	millsecs	2.52	2.08	5.72	4.88	9.33	13.31	7.92	7.19	9.55	10.23
Mech Time Constant	Tau_mch	millsecs	0.9	1.0	1.0	1.1	0.7	0.6	1.2	1.2	1.0	1.1
Rotor Inertia	J	lb-in-sec <sup>2</sup>	2.7E-4	2.7E-4	1.2E-3	1.23E-3	3.0E-3	3.0E-3	7.96E-03	7.96E-03	1.23E-02	1.23E-02
Rotor Inertia w/ brake	J	lb-in-sec <sup>2</sup>	3.8E-4	3.8E-4	1.6E-3	1.6E-3	3.9E-3	3.36E-4	8.85E-03	8.85E-03	1.42E-02	1.42E-02
Rotor Inertia	J	kgm <sup>2</sup>	0.302E-4	0.302E-4	1.4E-4	1.4E-4	3.36E-4	3.36E-4	9.00E-04	9.00E-04	1.40E-03	1.40E-03
Rotor Inertia w/ brake	J	kgm <sup>2</sup>	0.428E-4	0.428E-4	1.83E-4	1.83E-4	4.4E-4	4.4E-4	1.00E-03	1.00E-03	1.60E-03	1.60E-03
Rated Winding Temp	WTr	C	125	125	125	125	125	125	125	125	125	125
Rated Ambient Temp	Tamb	C	25	25	25	25	25	25	25	25	25	25
Rated Case Temp	Tcase	C	90	90	70	70	89	89	92	92	90	90
Number of Poles	Np		8	8	8	8	8	8	8	8	8	8
Weight	#	lbs	3.31	3.31	7.72	7.72	10.36	10.36	16.98	16.98	28.66	28.66
Weight w/ brake	#		3.97	3.97	9.26	9.26	11.68	11.68	21.38	21.38	35.27	35.27
Winding Class			H	H	H	H	H	H	H	H	H	H

- 1 @ 25° C ambient motor connected to a 10"x10"x1/4" aluminum mounting plate; @ 40° C ambient, derate phase currents and torques by 7%.
- 2 For higher-speed operation, please call the factory.
- 3 Measured line to line, +/- 10%.
- 4 Value is measured peak of sine wave.
- 5 +/- 30%, line to line, inductance bridge measurement @ 1Khz.
- 6 Initial winding temperature must be 60° C or less before peak

- 7 Direct current through a pair of motor phases of a trapezoidally (six state) commutated motor.
- 8 Peak of sinusoidal current in any phase for a sinusoidally commutated motor.
- 9 Total motor torque per peak of the sinusoidal amps measured in any phase, +/- 10%.
- 10 Maximum time duration with 2 times (or 3 times) rated current applied with initial winding temperature at 60° C.

Custom Designed Servo Motors For Your Specific Application. Call 1-800-358-9070 Today.

Dimensional SMN Motors  
SMNxx

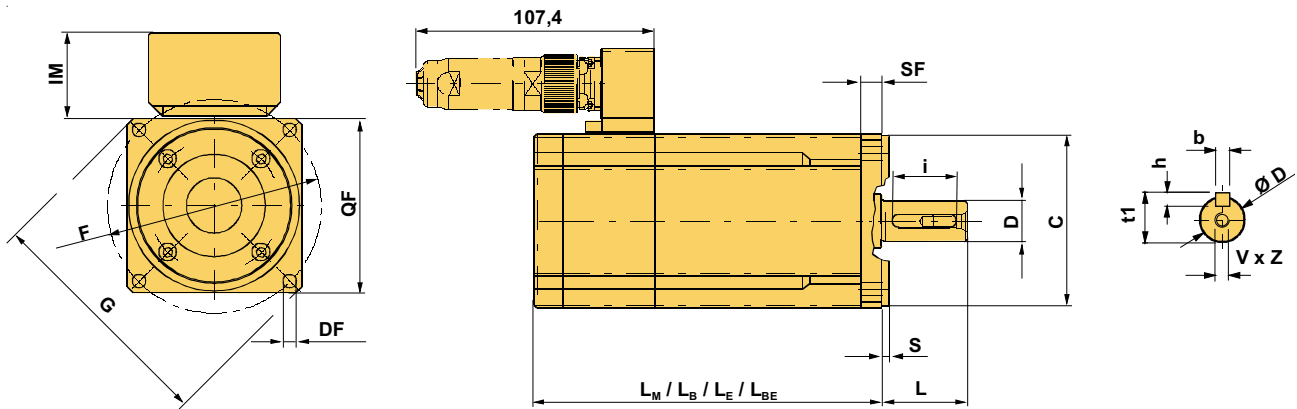

Motor	$L_M / L_B / L_E / L_{BE}$	SF	IM	Flange - type	DF	F	D x L	bxhxi	t1	V x Z	QF	C x S		G
SMN0602	129.5 / 161.0 / 163.0 / 209	7	40	5	6	75	11x23	4x4x18	12.5	M4x10	70	Ø60-h6	2.5	90
SMN0822	163.5 / 206.5 / 183.5 / 226.5	10	40	8	6.5	100	14x30	5x5x25	16	M5x12.5	82	Ø80-h6	3.5	112
SMN1002	191.5 / 238.5 / 211.5 / 258.5	10	40	5	9	115	19x40	6x6x30	21.5	M6x16	100	Ø95-h6	3.5	135
SMN1152	220/265/ 220 / 265	10	41.5	7	11	130	24x50	8x7x40	27	M8x19	130	Ø110-h6	3.5	156
SMN1422	243 / 293 / 243 / 293	12	41.5	5	11	165	24x50	8x7x40	27	M8x19	142	Ø130-h6	3.5	192.5

Stated in mm

Motor Length	Brake	Sin/Cos Encoder (5D)
$L_M$	-	-
$L_B$	●	-
$L_E$	-	●
$L_{BE}$	●	●

SMN0602 with Sin/Cos Encoder  
Option - 5D

