

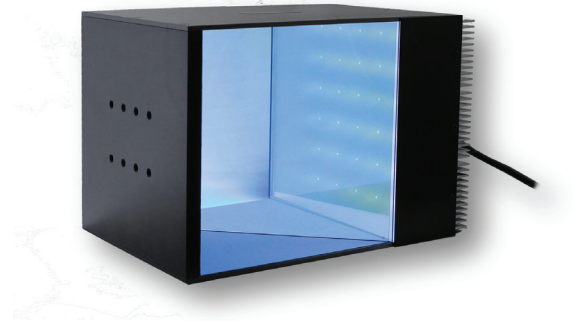



Product Highlights

- Consistent diffuse illumination over 150 x 150mm (6" x 6") the field of view
- Improved performance with unique modular heat sink and circuit design
- Excellent light stability
- Over twice as bright as the DL2449 and DL104
- Broad range of wavelengths available
- Five Sizes Available in series; 25, 50, 75, 100 and 150mm



General Specifications

	Color	24v Current	All Other Controls
Electrical Specifications	365, 375, 385, 395, 405	2.1	1.19 A Max
	590, 625	1.08	1.09 A Max
	455, 470, 530, WHI	2.16	1.09 A Max
	850	1.05	1.05 A Max
	940	2.1	1.05 A Max
Normal Operating Temperature	0 - 60°C		
Weight (g)	2863.1g (101oz) (6.321lb)		
Standard Cable Information	Up to 2 meters (80") long - 105°C rated PVC jacket, foil shield with drain.		
Photobiological Risk Factor IEC 62471	Exempt Applicable Wavelengths: 850, 940 Group 1 (Low-Risk) Applicable Wavelengths: 455, 470, 530, 590, 625, WHI Group 2 (Moderate Risk) Applicable Wavelengths: 365, 375, 385, 395, 405		
Compliance	  		
IP Rating	IP50		
Lumen Maintenance	L70 = 50,000 hours		

Mechanical Specifications

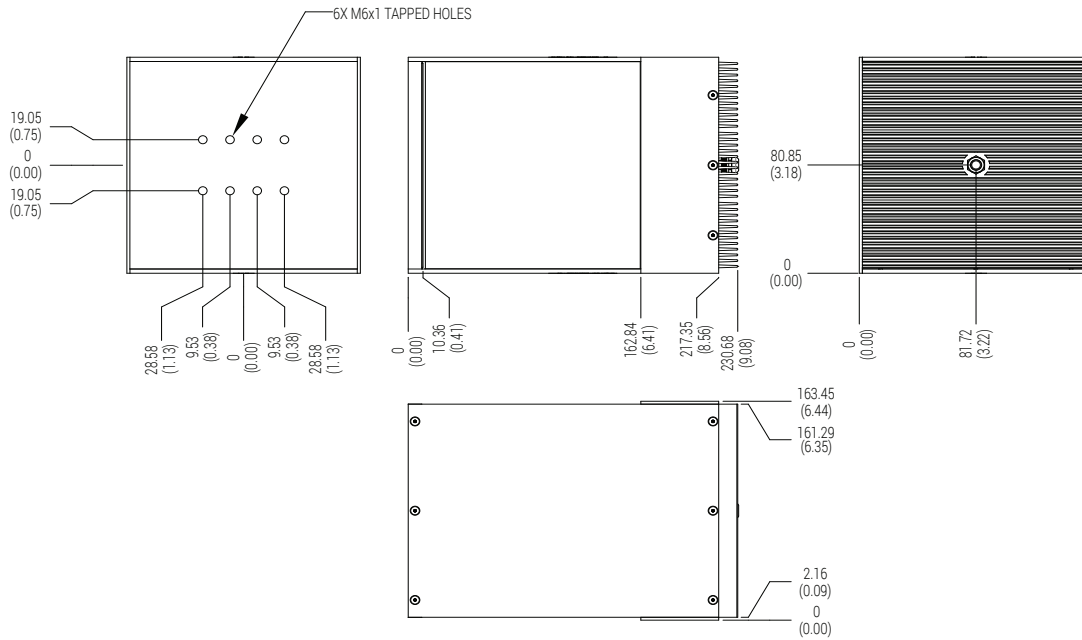

Part Number Key

Model	—	Lighted Length	Spectral Wavelength	Connector/Control	—	Alternative Connector
DL225	—	XXX	XXX	XX	—	XXX
DL225		150	(UV) 365 (UV) 375 (UV) 385 (UV) 395 (UV) 405 (deep blue) 455 (blue) 470 (green) 530 (amber) 590 (red) 625 (IR) 850 (IR) 940 (white) WHI	C1 C5 IC I3 I3S 24		M12 ¹
Ex: DL225-150470C1 DL225-150WHIIC-M12				¹ Available with IC, I3, I3S and 24v options only		

Stock Product: *shipped next day*
None

Build to Order: *shipped within two weeks*

Connector | Control Options

C1 Connector	C5 Connector	ICS 2 (IC)	ICS 3 (I3)	ICS 3S (I3S)	24
For use with: DCS Series Controllers	For use with: Pulsar 320 Strobe Controller.	Continous in-line controller Powered with: 24V power supply	Combination strobe/continous in-line controller Powered with: 24V power supply	Default-OFF strobe/continous in-line controller Powered with: 24V power supply	Flying/tinned leads Powered with: 24V power supply

Optical Performance

Intensity Distribution

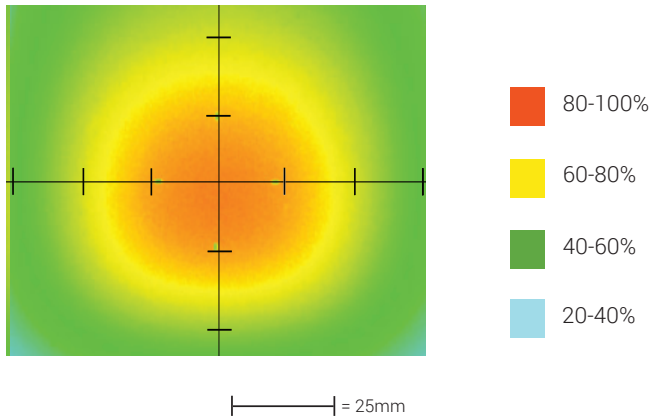

Optical measurement taken using DL225-150WHIIC @ 25 mm

Area of Illuminance & Intensity

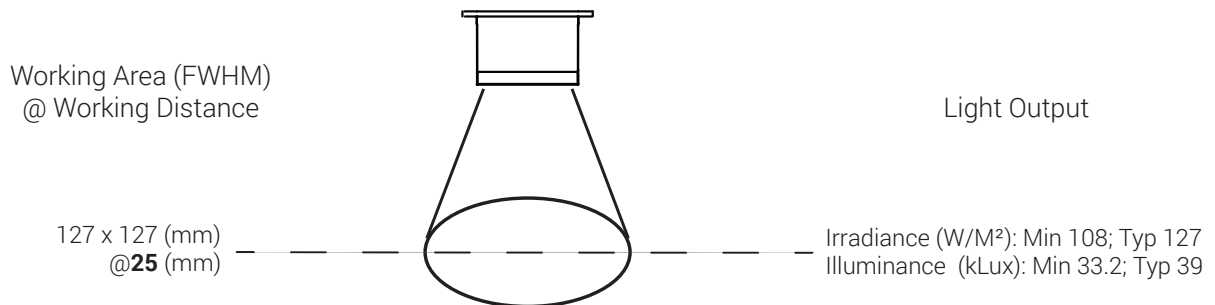

Operation and Wiring

ICS 2 (IC)

Pin (M12)	Function	Wire Color
1	+24 VDC	Brown
2	0-10 VDC Analog Control	White
3	DCGND	Blue
4	GLO	Black

ICS 3 (I3 and I3S)

Pin (M12)	Function	Wire Color
1	+24 VDC	Brown
2	Reserved	White
3	GND	Blue
4	PNP/Active High Trigger	Black
5	0-10 VDC Analog Control	Gray

24 Volt

Pin (M12)	Function	Wire Color
1	+24 VDC	Brown
2	N/A	White
3	GND	Blue
4	N/A	Black

Optional M12 Pinout

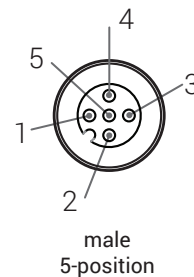

Warranty Information

Every Advanced illumination, Inc. (Ai) product is thoroughly inspected and tested before leaving the factory. Products are warranted to be free of defects in workmanship and materials for a period of two years from the original date of purchase. Should a defect develop during this period, please contact Ai Customer Service or your Ai distributor for a Return Merchandise Authorization (RMA), and return the complete product, freight prepaid, to Ai. If a defect is found, Ai will - at our discretion - repair or replace the product without charge. Ai claims no liability for any implied warranties, including "merchantability" and "fitness for a specific purpose."

Electromagnetic Compatibility

This product was tested and complies with the regulatory requirements and limits for electromagnetic compatibility (EMC) as stated in the product specifications. These requirements and limits are designed to provide reasonable protection against harmful interference only when the product is operated in its intended industrial electromagnetic environment. To minimize the potential for electromagnetic interference or unacceptable performance degradation, install and use this product in strict accordance with the instructions in the product documentation.

Customer Service

For information on existing orders, or to make an order adjustment, contact us Monday through Friday 8:00 am to 5:00 pm, EST or send an email to orders@advill.com.

Company Information

Advanced Illumination

440 State Garage Road, Rochester VT. 05767

Phone: 802.767.3830

Fax: 802.767.3831

Email: info@advancedillumination.com

Web: advancedillumination.com

© 2015 Advanced Illumination Inc. All rights reserved