



### Product Highlights

- Light weight, efficient space saving design
- Axial light source designed for small, non-specular objects or inspections with limited space



### General Specifications

	Color	24v Current	All Other Controls
Electrical Specifications	625, 660, 880	0.12 A	0.06 A Max
	395, 470, 520, WHI	0.08 A	0.04 A Max
Normal Operating Temperature	0 - 60°C		
Weight (g)	58.9g (2.08 oz)		
Standard Cable Information	Up to 2 meters (80") long - 105°C rated PVC jacket, foil shield with drain.		
Photobiological Risk Factor IEC 62471	<b>Exempt Applicable Wavelengths:</b> 880 <b>Group 1 (Low-Risk) Applicable Wavelengths:</b> 470, 520, 625, 660, WHI <b>Group 2 (Moderate Risk) Applicable Wavelengths:</b> 395		
Compliance	  		
IP Rating	IP40		
Lumen Maintenance	L70 = 50,000 hours		

## Mechanical Specifications

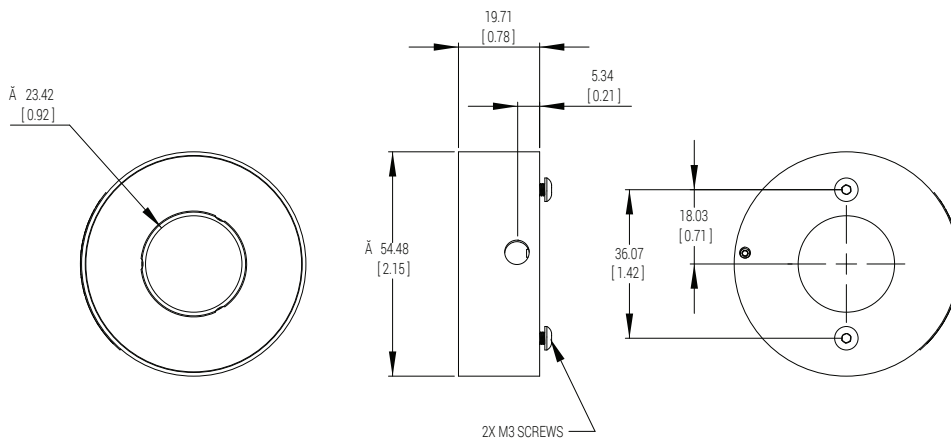

DIMENSIONS ARE IN MILLIMETERS [INCHES]

## Part Number Key

Model	—	Spectral Wavelength	Stand Off	Fied of View	Connector/ Control	Optional Lighting Condition	—	Alternative Connector
<b>RL2316</b>	<b>—</b>	<b>XXX</b>	<b>XXX</b>	<b>XXX</b>	<b>XX</b>	<b>X</b>	<b>—</b>	<b>XXX</b>
RL2316		(UV) 395 <sup>2</sup> (blue) 470 (green) 520 (red orange) 625 (red) 660 (infra red) 880 (white) WHI	See chart to compute standoff.	XS S M L XL XXL	C1 C5 IC I3 I3S 24	D (Diffuser) P <sup>3</sup> (Polarizer)		M12 <sup>1</sup>
Ex: <b>RL2316-395100XXLC1D</b> <b>RL2316-625150XL I3P-M12</b>						<sup>1</sup> Available with IC, I3, I3S and 24 options only <sup>2</sup> Not available with IC and 24 options <sup>3</sup> Not available with UV option (blue) 470 will reduce the life of the polarizer		

**Stock Product:** *shipped within 3 days*  
None

**Build to Order:** *shipped within 2 weeks*

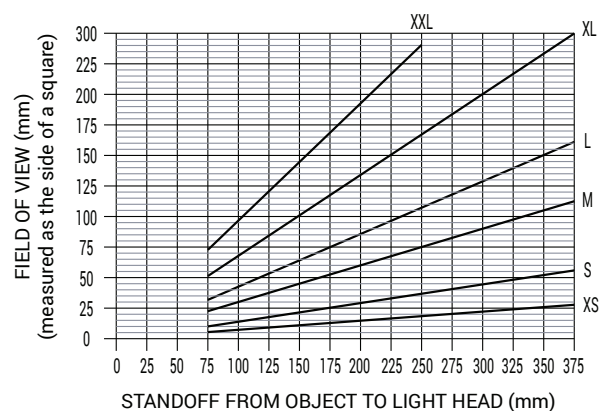

• Identify desired FOV and standoff, then specify nearest illuminated area size

## Connector | Control Options

C1 Connector	C5 Connector	ICS 2 (IC)	ICS 3 (I3)	ICS 3S (I3S)	24
For use with: <b>DCS Series Controllers</b>	For use with: <b>Pulsar 320 Strobe Controller.</b>	Continuous in-line controller  Powered with: <b>24V power supply</b>	Combination strobe/continuous in-line controller  Powered with: <b>24V power supply</b>	Default-OFF strobe/continuous in-line controller  Powered with: <b>24V power supply</b>	Flying/tinned leads  Powered with: <b>24V power supply</b>

## Optical Performance

### Intensity Distribution

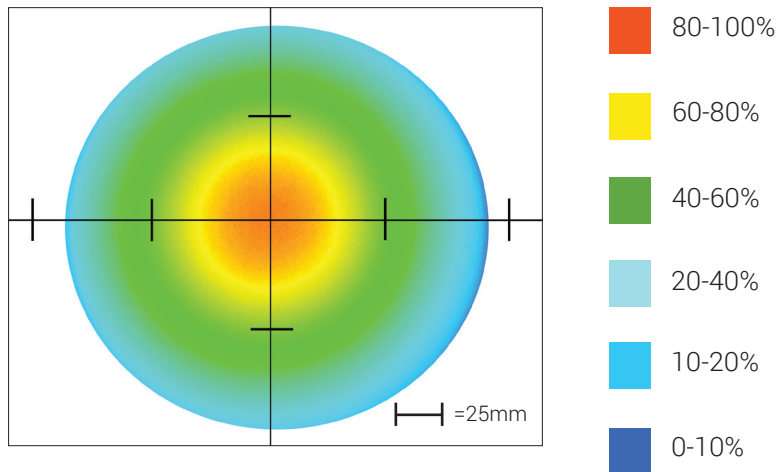

Optical measurement taken using RL2316-625100LI3 @ 100 mm

### Area of Illuminance & Intensity

Working Area (FWHM)  
@ Working Distance

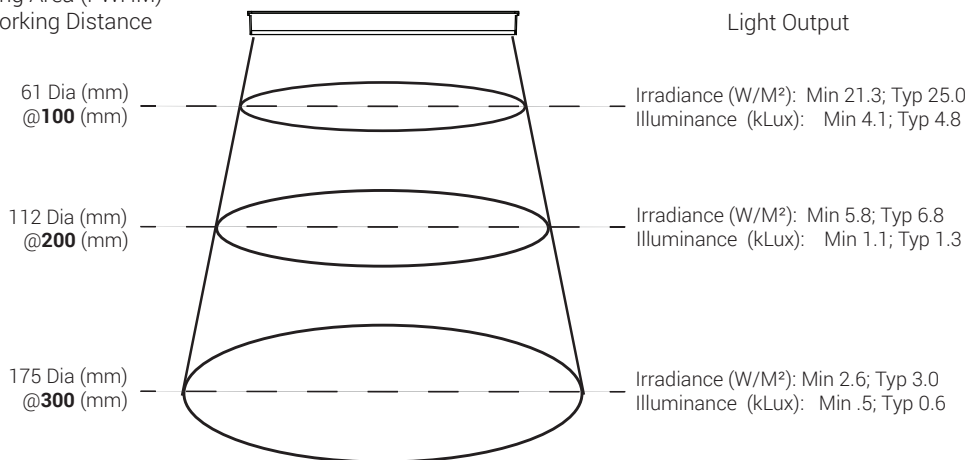

## Operation and Wiring

### ICS 2 (IC)

Pin (M12)	Function	Wire Color
1	+24 VDC	Brown
2	0-10 VDC Analog Control	White
3	DCGND	Blue
4	GLO	Black

### ICS 3 (I3 and I3S)

Pin (M12)	Function	Wire Color
1	+24 VDC	Brown
2	Reserved	White
3	GND	Blue
4	PNP/Active High Trigger	Black
5	0-10 VDC Analog Control	Gray

### 24 Volt

Pin (M12)	Function	Wire Color
1	+24 VDC	Brown
2	N/A	White
3	GND	Blue
4	N/A	Black

### Optional M12 Pinout

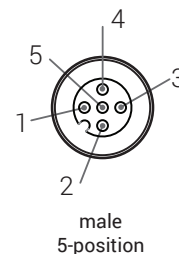

## Warranty Information

Every Advanced illumination, Inc. (Ai) product is thoroughly inspected and tested before leaving the factory. Products are warranted to be free of defects in workmanship and materials for a period of two years from the original date of purchase. Should a defect develop during this period, please contact Ai Customer Service or your Ai distributor for a Return Merchandise Authorization (RMA), and return the complete product, freight prepaid, to Ai. If a defect is found, Ai will - at our discretion - repair or replace the product without charge. Ai claims no liability for any implied warranties, including "merchantability" and "fitness for a specific purpose."

## Electromagnetic Compatibility

This product was tested and complies with the regulatory requirements and limits for electromagnetic compatibility (EMC) as stated in the product specifications. These requirements and limits are designed to provide reasonable protection against harmful interference only when the product is operated in its intended industrial electromagnetic environment. To minimize the potential for electromagnetic interference or unacceptable performance degradation, install and use this product in strict accordance with the instructions in the product documentation.

## Customer Service

For information on existing orders, or to make an order adjustment, contact us Monday through Friday 8:00 am to 5:00 pm, EST or send an email to [orders@advill.com](mailto:orders@advill.com).

## Company Information

### **Advanced Illumination**

440 State Garage Road, Rochester VT. 05767

Phone: 802.767.3830

Fax: 802.767.3831

Email: [info@advancedillumination.com](mailto:info@advancedillumination.com)

Web: [advancedillumination.com](http://advancedillumination.com)

© 2015 Advanced Illumination Inc. All rights reserved