

## VL-CT55 Series Specifications

Parameter	Value	Units		
<b>Configuration &amp; Physical Parameters</b>				
Motor	Animatics SmartMotors NEMA 23	-		
Coupling	Beam	-		
Ball Screw Leads	12	mm/rev		
Position Sensors	consult factory	-		
Stroke Lengths	50 - 300mm in 50mm steps	mm		
Overall Length	Stroke + 274.9	mm		
Over-Travel	0	mm		
Unit Mass	1.94 + (stroke, mm)*0.0075	kg		
<b>Performance</b>				
Unidirectional Repeatability	20	µm		
Bi-directional Repeatability	40	µm		
Accuracy	0.021/300	mm/mm		
Max Velocity	470 -1000 (stroke dependant)	mm/s		
Max Acceration	0.3	G		
Payload Mass	22	kg		
Rated Velocity	400	mm/s		
Lifetime*	15000	hr		
<b>Load Rating, Dynamic</b>				
Using SM23165DT motor	Direct Drive	2:1 pulley**	3:1 pulley**	-
Max Continuous Thrust	262	490	737	N
Max Peak Thrust	394	788	1182	N

\* Based on operating at an average speed of the rated velocity at the given payload. The Lifetime will be significantly reduced operating above the Rated Velocity and/or given payload.

\*\*Please see pages 105 for pulley offset CAD drawings.



VL-CT55 series - Direct Drive

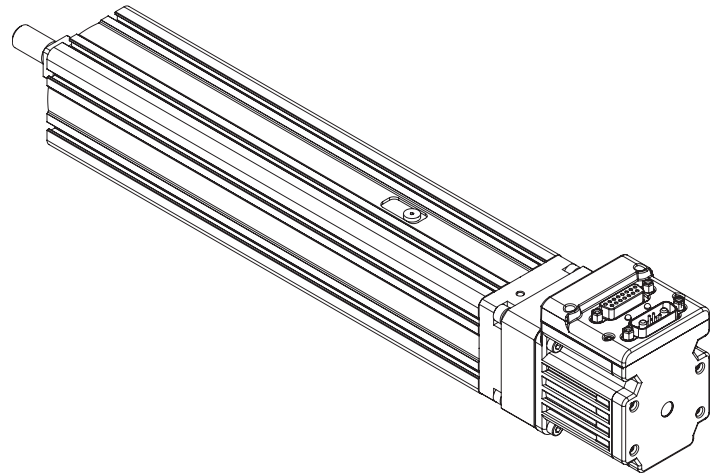

### WARNING: Do not exceed these limits

VL-CT series - Maximum Permissible Carriage Velocity

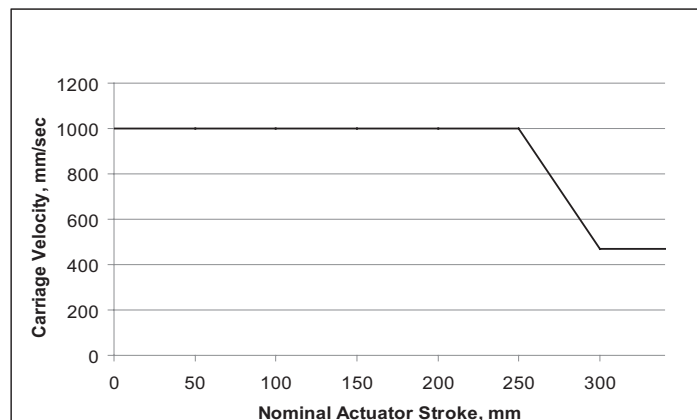

VL-CT series - Maximum Permissible Screw Speed

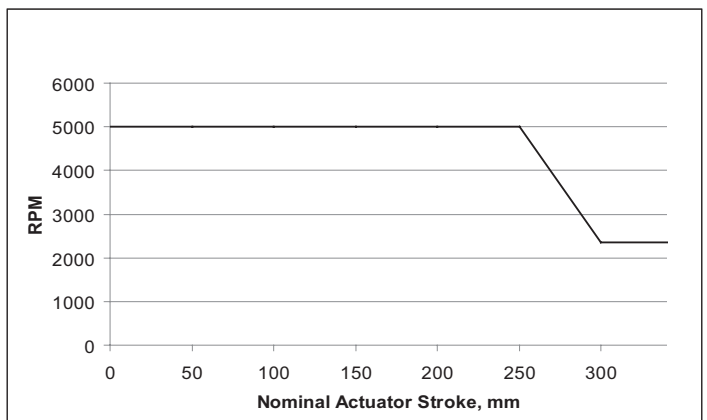

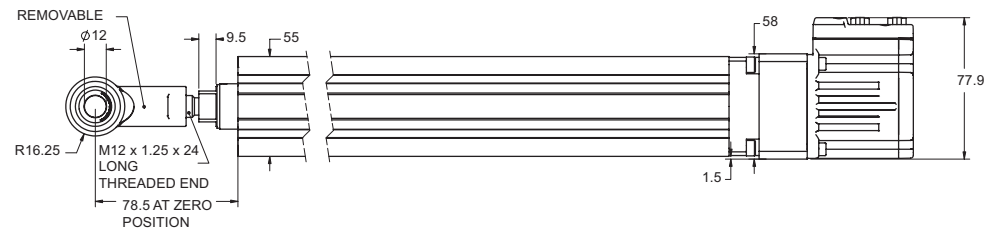
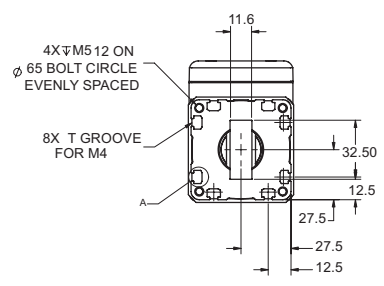
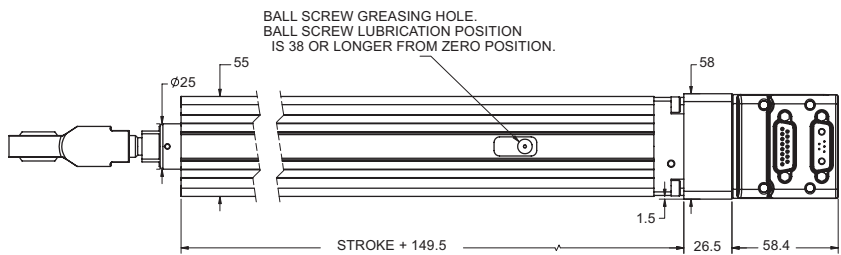
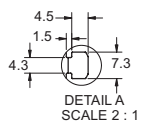

Dimensions in millimeters

Note: For part numbers please refer to our Website at [www.oemdynamics.com](http://www.oemdynamics.com)

**Thrust Curve performance data in following section on page 109-126**