

## VL-CT35 Series Specifications

Parameter	Value	Units			
<b>Configuration &amp; Physical Parameters</b>					
Motor	23 frame D-series SmartMotors ONLY	-			
Coupling	Beam	-			
Displacement/rev	6,12	mm/rev			
Position Sensors	consult factory	-			
Stroke Lengths	50, 100 and 150	mm			
Overall Length	Stroke + 244.9 + motor	mm			
Overtravel	None	mm			
Unit Mass	1.1667 + (stroke, mm)*0.003	kg			
<b>Performance</b>					
Unidirectional Repeatability	20	µm			
Bidirectional Repeatability	40	µm			
Linear Accuracy	0.21/300	mm/mm			
Max Velocity	470 – 1000 (stroke dependent)	mm/s			
Max Acceleration	0.3	G			
Payload Mass	5.6	kg			
Rated Velocity	400	mm/s			
Lifetime*	15000	hr			
<b>Load Rating, Dynamic</b>					
Using SM23165DT motor	<b>Direct Drive</b>	<b>2:1 pulley**</b>	-		
Displacement/rev	<b>6</b>	<b>12</b>	<b>6</b>	<b>12</b>	mm/rev
Max Continuous Thrust	461	231	922	461	N
Max Peak Thrust	745	372	1490	745	N

\*Based on operating at an average speed of the rated velocity at the given payload. The Lifetime will be significantly reduced operating above the rated velocity and/or given payload.

\*\*Please see page 155 for pulley offset CAD drawings.



VL-CT35 series

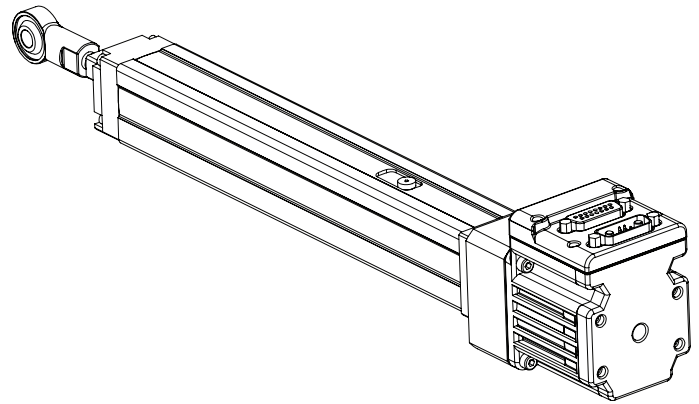

### WARNING: Do not exceed these limits

VL-CT series - Maximum Permissible Carriage Velocity

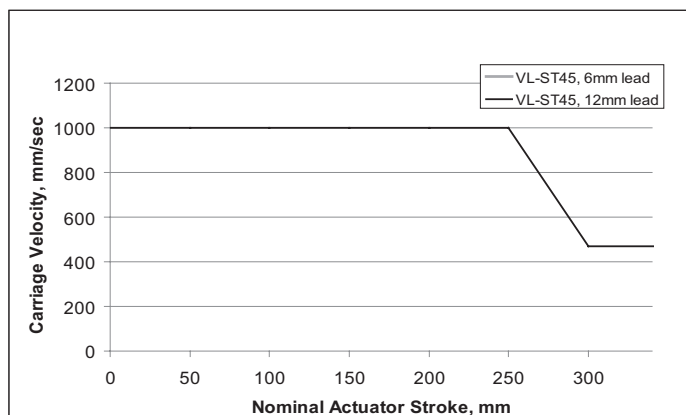

VL-CT series - Maximum Permissible Screw Speed

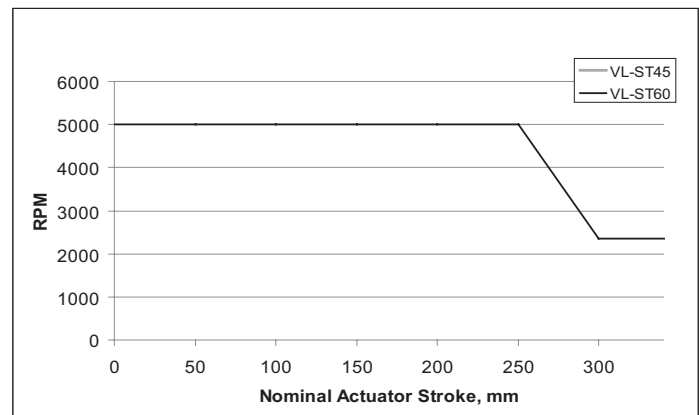

**WARNING: Exceeding thrust, speed, or moment loading specifications could result in immediate damage to the actuators. Doing so will void the warranty.**

OVERVIEW

SOFTWARE

D-STYLE MOTORS

D-STYLE CONNECTIVITY

PERIPHERALS

M-STYLE MOTORS

M-STYLE CONNECTIVITY

LINEAR SYSTEMS

POWER SUPPLIES &amp; SHUNTS

GEAR HEADS

APPENDIX

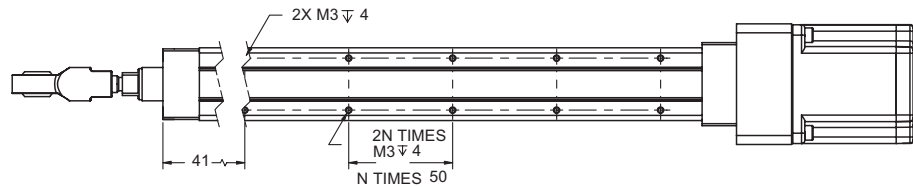
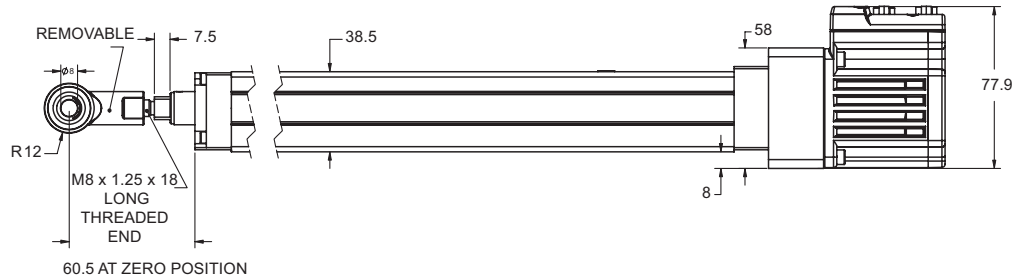
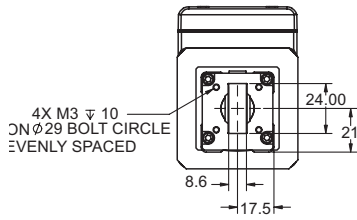
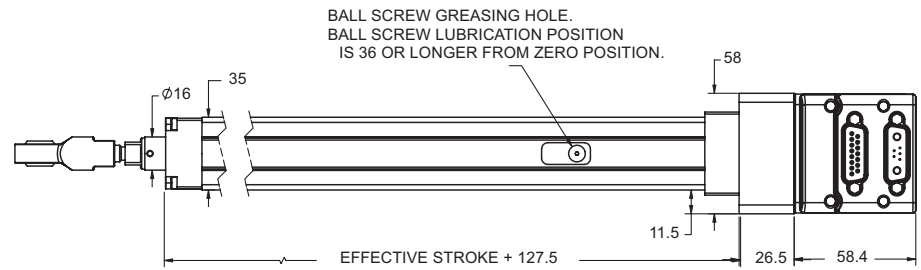

Dimensions in millimeters

**NOTE:** For part numbers please refer to our website at [www.animatics.com](http://www.animatics.com)

For Thrust Curve performance data, see pages 158–173.