

CONTROL MODES

- Indexer, Point-to-Point, PVT
- Camming, Gearing, Position, Velocity, Torque

COMMAND INTERFACE

- CANopen
- ASCII and discrete I/O
- Stepper commands
- ± 10 Vdc analog position/velocity/torque *
- PWM velocity/torque command
- Master encoder (Gearing/Camming)

COMMUNICATIONS

- CANopen
- RS-232

FEEDBACK

- Digital Quad A/B encoder
- Secondary encoder / emulated encoder out
- Brushless resolver (-R option)
- Digital Halls

I/O - DIGITAL

- 10 inputs, 2 outputs

DIMENSIONS: MM [IN]

- 102 x 69 x 25 [4.0 x 2.7 x 1.0]

* Available on RoHS versions

CANopen®



Model *	Vdc	Ic	Ip
ACM-055-18	20 - 55	6	18
ACM-090-09	20 - 90	3	9
ACM-090-24	20 - 90	12	24
ACM-180-09	20 - 180	3	9
ACM-180-18	20 - 180	6	18
ACM-180-20	20 - 180	10	20

Add -R to part numbers above for resolver feedback

DESCRIPTION

Accelnet is a digital servo drive that combines CANopen networking with 100% digital control of brush or brushless motors in a pc board mounting package with power options to 10 Adc continuous and 20 Adc peak from 20 Vdc to 180 Vdc power supplies.

RoHS compliance is now standard on all models and with this a ± 10 Vdc analog input has been added for position/velocity/torque control. The input takes the place of signal ground pins on non RoHS models so that RoHS types can be installed in place of non RoHS types with no change in function.

Accelnet operates as a Motion Control Device using the DSP-402 protocol under the CANopen DS-301 V4.01 (EN 50325-4) application layer. DSP-402 modes supported include Interpolated Position (PVT), Profile Position, Profile Velocity, Profile Torque, and Homing.

Ten logic inputs are configurable as CAN address bits, enables, limit & home switches, motor temperature switch, stepper/encoder pulses, and reset. There are two logic outputs for reporting drive status, or driving a motor brake.

In addition to CANopen motion commands, *Accelnet* can operate using incremental position commands from step-motor controllers in Pls/Dir or CW/CCW format, as well as A/B quadrature commands from a master-encoder which can drive cam tables or be geared to ratio the drive position to that of the master-encoder.

Drive commissioning is facilitated by CME 2™ software operating under Windows® communicating with *Accelnet* via an RS-232 link. Auto-tuning algorithms in CME 2™ slash set up times for fast system commissioning by automating motor phasing, and current-loop tuning. A powerful oscilloscope and waveform generator display drive performance for fine tuning. Drive configurations are saved in non-volatile flash memory. OEM's can inventory one part, and configure drives on-site to each axis in a machine.

Space-vector modulation delivers higher motor speeds and lower motor power dissipation than conventional sine-pwm modulation. Carrier-cancellation modulation all but eliminates motor ripple current and dissipation at a standstill. Current-loop sampling is at 15 kHz, position and velocity loops at 3 kHz and PWM ripple at 30 kHz.

All drive circuits are DC coupled and operate from unregulated transformer-isolated linear DC power supplies, or regulated switch-mode power supplies.

The PC board mounting package is suitable for high density, multi-axis installations in equipment where space is at a premium, and wiring must be minimized.

GENERAL SPECIFICATIONS

Test conditions: Load = Wye connected load: 1 mH+ 1Ω line-line. Ambient temperature = 25 °C. +HV = HV_{max}

MODEL	ACM-055-18	ACM-090-09	ACM-090-24	ACM-180-09	ACM-180-18	ACM-180-20	
OUTPUT POWER							
Peak Current	18 (12.7)	9 (6.34)	24 (17.0)	9 (6.34)	18 (12.7)	20 (14.14)	Adc (Arms, sinusoidal)
Peak time	1	1	1	1	1	1	Sec
Continuous current	6 (4.24)	3 (2.1)	12 (8.5)	3 (2.1)	6 (4.24)	10 (7.1)	Adc (Arms, sinusoidal)
Peak Output Power	0.99	0.81	2.16	1.62	3.24	3.6	kW
Continuous Output Power	0.33	0.27	1.08	0.54	1.08	1.8	kW
INPUT POWER							
HVmin to HVmax	+20 to +55	+20 to +90	+20 to +90	+20 to +180	+20 to +180	+20 to +180	Vdc, transformer-isolated
Ipeak	18	9	24	9	18	20	Adc (1 sec) peak
Icont	6	3	12	3	6	10	Adc continuous
Aux HV	+20 to HV _{max}	2.5 W maxOptional keep-alive power input when +HV is removed					
PWM OUTPUTS							
Type	MOSFET 3-phase inverter, 15 kHz center-weighted PWM carrier, space-vector modulation						
PWM ripple frequency	30 kHz						
BANDWIDTH							
Current loop, small signal	2.5 kHz typical, bandwidth will vary with tuning & load inductance						
HV Compensation	Changes in HV do not affect bandwidth						
Current loop update rate	15 kHz (66.7 μs)						
Position & Velocity loop update rate	3 kHz (333 μs)						
COMMAND INPUTS							
CANopen bus	Operating Modes		Profile Position, Profile Velocity, Profile Torque Interpolated Position (PVT), Homing				
Digital position reference	Pls/Dir, CW/CCW Quad A/B Encoder		Stepper commands (2 MHz maximum rate) 2 Mline/sec, (8 Mcount/sec after quadrature)				
Digital torque & velocity reference (Note 1)	PWM , Polarity PWM		PWM = 0~100%, Polarity = 1/0 PWM = 50% +/-50%, no polarity signal required				
	PWM frequency range PWM minimum pulse width		1 kHz minimum, 100 kHz maximum 220 ns				
Analog torque/velocity/position	±10 Vdc, 5 kΩ differential input impedance (only on RoHS models with green leaf on label)						
DIGITAL INPUTS (NOTE 1)							
Number	10						
All inputs	74HC14 Schmitt trigger operating from +5 Vdc with RC filter on input, and pull-ups to +5 Vdc RC time-constants assume active drive on inputs and do not include pull-ups Active level of all inputs is selectable, functions of [IN2~10] are selectable Vin-LO < 1.35 Vdc, Vin-HI > 3.65 Vdc for all inputs						
Logic levels	1 dedicated input for drive enable, 10 kΩ pull-up, 330 μs RC filter, 24 Vdc max						
Enable [IN1]	3 General Purpose inputs, 10 kΩ pull-ups, 330 μs RC filter (33 μs for [IN4]), 24 Vdc max						
GP [IN2,3,4]	1 General Purpose input with, 4.99 kΩ pull-up, 330 μs RC filter, 24 Vdc max						
Motemp [IN5]	5 High-Speed inputs, 10 kΩ pull-ups, with 100 ns RC filter, 12 Vdc max						
HS [IN6,7,8,9,10]							
DIGITAL OUTPUTS (NOTE 1)							
Number	2						
Type	Current-sinking MOSFET open-drain output with 1 kΩ pull-up to +5 Vdc through diode 300 mAdc sink max, +30 Vdc max Programmable with CME 2™						
Functions	Programmable to either HI (off, pull-up to +5 Vdc) or LO (on, current-sinking) when output is active						
Active Level							
RS-232 COMMUNICATION PORT							
Signals	RxD, TxD, Gnd Full-duplex, serial communication port for drive setup and control, 9,600 to 115,200 Baud						
CANOPEN COMMUNICATION PORT							
Signals	CANH, CANL, Gnd. 1 Mbit/sec maximum.						
Protocol	CANopen Application Layer DS-301 V4.01						
Device	DSP-402 Device Profile for Drives and Motion Control						
MOTOR CONNECTIONS							
Motor U,V,W	Drive outputs to 3-phase brushless motor, Wye or delta connected (DC brush motor use outputs U & V)						
Encoder	Quadrature encoder, differential outputs (A,/A,B,/B,X,/X), 5 Mlines/sec (20 Mcount/sec after quadrature)						
Resolver	R1, R2, S3, S1, S2, S4 (-R option)						
Halls	Hall signals (U,V,W)						
Motemp	Motor temperature sensor or switch						
RESOLVER							
Type	Brushless, single-speed, 1:1 to 2:1 programmable transformation ratio						
Resolution	14 bits (equivalent to a 4096 line quadrature encoder)						
Reference frequency	7.5 kHz						
Reference voltage	2.8 Vrms, auto-adjustable by the drive to maximize feedback						
Reference maximum current	100 mA						
Maximum RPM	10,000+						
PROTECTIONS							
HV Overvoltage	+185, +91, +56 Vdc	Drive outputs turn off until +HV is < overvoltage (for 180, 90, 55 Vdc models)					
HV Undervoltage	+HV < +20 Vdc	Drive outputs turn off until +HV >= +20 Vdc					
Drive over temperature	PC Board > 70 °C.	Drive latches OFF until drive is reset, or powered off-on					
Short circuits		Output to output, output to ground, internal PWM bridge faults					
I ² T Current limiting		Programmable: continuous current, peak current, peak time					
Latching / Non-Latching		Programmable					
NOTES							
1. [IN1] is not programmable and always works as drive Enable. Other digital inputs are programmable.							

MECHANICAL & ENVIRONMENTAL

Size	4.05 in (102.7 mm) X 2.62 in (66.5 mm) X 0.92 in (24.9 mm)
Weight	5.7 oz (0.16 kg)
Ambient temperature	0 to +45°C operating, -40 to +85°C storage
Humidity	0 to 95%, non-condensing
Vibration	2 g peak, 10~500 Hz (sine), IEC60068-2-6
Shock	10 g, 10 ms, half-sine pulse, IEC60068-2-27
Contaminants	Pollution degree 2
Environment	IEC68-2: 1990
Cooling	Heatsink required for continuous power output

AGENCY STANDARDS CONFORMANCE

EN 55011 : 1998	CISPR 11 (1997) Edition 2/Amendment 2: Limits and Methods of Measurement of Radio Disturbance Characteristics of Industrial, Scientific, and Medical (ISM) Radio Frequency Equipment
EN 61000-6-1 : 2001	Electromagnetic Compatibility Generic Immunity Requirements
Following the provisions of EC Directive 89/336/EEC:	
EN 60204-1 : 1997	Safety of Machinery - Electrical Equipment of Machines
Following the provisions of EC Directive 98/37/EC:	
UL 508C 3 rd Ed. : 2002	UL Standard for Safety for Power Conversion Equipment

ACCELNET MODULE FEATURES

CANOPEN NETWORKING

Based on the CAN physical layer, a robust, two-wire communication bus originally designed for automotive use where low-cost and noise-immunity are essential, CANopen adds support for motion-control devices and command synchronization. The result is a highly effective combination of data-rate and low-cost for multi-axis motion control systems. Device synchronization enables multiple axes to coordinate moves as if they were driven from a single control card.

CANOPEN COMMUNICATION

Accelnet uses the CAN physical layer signals CANH, CANL, and GND for connection, and CANopen protocol for communication.

Before connecting *Accelnet* to the CAN network, it must be assigned a CAN address. This is done via the RS-232 port, which is also used for general drive setup. The CAN address is a combination of an internal address stored in flash memory, and digital inputs which have been configured to act as CAN address bits. A maximum of 127 CAN devices are allowed on a CAN bus network, so this limits the input pins used for this purpose to a maximum of seven, leaving three inputs available for other purposes. Most installations will use less than the maximum number of CAN devices, in which case the number of inputs used for a CAN address can be less than seven, leaving more inputs available for other functions.

When inputs are used for the CAN address bits, the internal address is added to the binary value that results from the inputs. If all the inputs are used as logic inputs, then the CAN address in flash memory is the drive CAN address.

RS-232 COMMUNICATION

Accelnet is configured via a three-wire, full-duplex RS-232 port that operates from 9,600 to 115,200 Baud. CME 2™ software provides a graphic user interface (GUI) to set up all of *Accelnet* features via a computer serial port.

The RS-232 port is used for drive set up and configuration. Once configured, *Accelnet* can be used in stand-alone mode taking digital position, velocity, or torque commands from a controller, or as a networked drive on a CANopen bus.

REFERENCE INPUTS

As a network drive, the primary command input is the CANopen bus. But, *Accelnet* can also operate in stand-alone mode, taking position, velocity, or current (torque, force) commands in digital format or $\pm 10V$ from a motion controller.

DIGITAL REFERENCE INPUTS

Two logic inputs are used as digital reference inputs in the stand-alone mode. These will be assigned automatically to inputs that have the HS filters.

Current (torque, force) mode commands can be in one or two-wire format. In the one-wire format (50% PWM), a single input takes a square waveform that has a 50% duty cycle when the drive output should be zero. Thereafter, increasing the duty cycle to 100% will command an output current that will produce a maximum force or torque in a positive direction of motion, and decreasing the duty cycle to 0% will produce a maximum negative torque or force output.

In two-wire format (PWM/Dir), one input takes a PWM waveform of fixed frequency and variable duty cycle, and the other input takes a DC level that controls the polarity of the output current. The active level of the PWM signal for 0 current output is programmable. The direction of the force or torque produced will depend on the polarity of the DC signal on the direction input.

PWM/DIR INPUTS

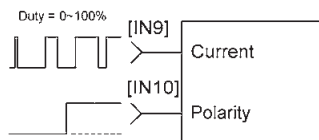

PC BOARD MOUNTING

The small size, and cooling options enable *Accelnet* to be integrated into machinery with fewer cables and connections, and closer to the motor when required. Copley provides standard and low-profile heatsinks to match drive dissipation with ambient temperature and mounting conditions. In addition, the *Accelnet* case has tabs molded-in that accept Socket-A compatible chip-coolers (not available from Copley) which have integral fans to provide even greater cooling capacity.

PWM 50% INPUTS

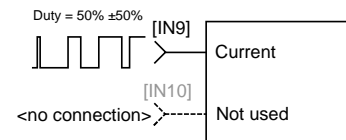

ANALOG COMMAND INPUT

RoHS models (green leaf on label) now feature an analog input for position/velocity/torque control. When using this input, Ref(+) and Ref(-) must both be connected to the controller. This differential connection is important for two reasons. First, for rejection of noise between controller and drive grounds. Second, because if one Ref input is left open, grounding of the other input will produce a ±2% of peak-current command, not a 0% command.

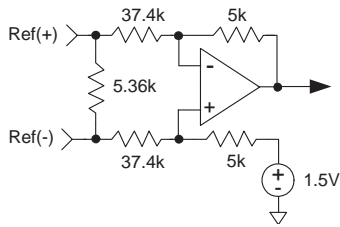

DIGITAL OUTPUTS

The digital outputs [OUT1], and [OUT2] are open-drain MOSFETs with 1 kΩ pull-up resistors in series with a diode to +5 Vdc. They can sink up to 300 mAdc from external loads operating from power supplies to +30 Vdc.

The outputs are typically configured as drive fault and motor brake. Additional functions are programmable.

As a drive fault output, the active level is programmable to be HI or LO when a drive fault occurs. As a brake output, it is programmable to be either HI or LO to release a motor brake when the drive is enabled.

When driving inductive loads such as a relay, an external fly-back diode is required. A diode in the output is for driving PLC inputs that are opto-isolated and connected to +24 Vdc. The diode prevents conduction from +24 Vdc through the 1 kΩ resistor to +5 Vdc in the drive. This could turn the PLC input on, giving a false indication of the drive output state.

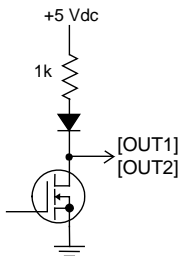

DIGITAL INPUTS

There are ten digital inputs to Accelnet, nine of which can be programmed to a selection of functions. The Enable input which controls the on/off state of the PWM outputs is fixed to [IN1] as a safety measure so that cannot be programmed in such a way that, once installed, it could not be shut down by the controller. The other nine inputs can be set to a selection of functions. Two types of RC filters are used: GP (General Purpose), and HS (High-Speed). Input functions such as Pulse/Direction, CW/CCW, Quad A/B typically are wired to inputs having the HS filters, and inputs with the GP filters are used for general purpose logic functions, limit switches, and the motor temperature sensor. Input [IN4] has a 33 μs RC filter.

Programmable functions of the I/O inputs are:

- Positive Limit switch
- Negative Limit switch
- Home switch
- Drive Reset
- PWM current or velocity control
- CAN address
- Pls/Dir, or CW/CCW step motor control pulses
- Quad A/B master encoder position commands
- Motor temperature sensor or switch input
- Motion Profile Abort

In addition to the selection of functions, the active level for each input is individually programmable.

Drive reset takes place on transitions of the input and is programmable to 1/0 or 0/1. The motor temp sensor function will disable the drive if a switch in the motor opens or closes when the motor overheats.

GENERAL-PURPOSE INPUTS

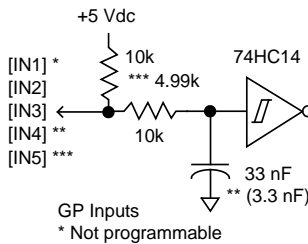

HIGH-SPEED INPUTS

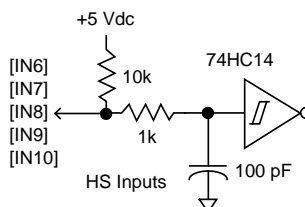

CAM MASTER

When operating in Camming mode an incremental encoder may be the Master input and connects to [IN9] and [IN10]. Other types of digital signals can be used, too. Pulse & Direction or Pulse-Up/Pulse-Down formats are supported.

QUAD A/B ENCODER

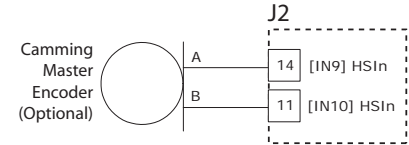

PULSE-UP, PULSE-DOWN

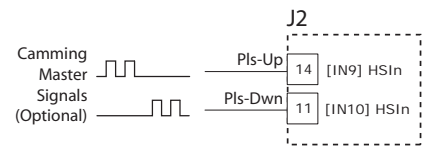

PULSE-DIRECTION

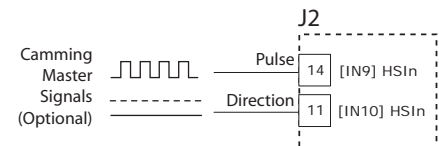

MOTOR CONNECTIONS

Motor connections are of three types: phase, Halls, and encoder. The phase connections carry the drive output currents that drive the motor to produce motion. The Hall signals are three digital signals that give absolute position feedback within an electrical commutation cycle. The encoder signals give incremental position feedback and are used for velocity and position modes, as well as sinusoidal commutation.

MOTOR ENCODER

The motor encoder interface is a differential line-receiver with R-C filtering on the inputs. Encoders with differential outputs are preferred because they are less susceptible to noise that can be picked on single-ended outputs. PC board layouts should route the encoder signal-pairs as close to each other as possible for best transmission-line characteristics. If single-ended encoders are used, a pull-up resistor should be installed on the PC board, and the unused input can be left open. If this is done, it is recommended that the inverting input be left open as its' open-circuit voltage of 2.0 Vdc (typical) is closer to TTL and CMOS levels than the non-inverting input which has an open-circuit voltage of 2.9 Vdc (typical). The encoder input circuit is shown below.

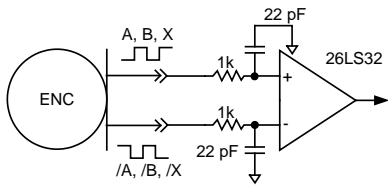

MOTOR HALL SIGNALS

Hall signals are single-ended signals that provide absolute feedback within one electrical cycle of the motor. There are three of them (U, V, & W) and they may be sourced by magnetic sensors in the motor, or by encoders that have Hall tracks as part of the encoder disc. They typically operate at much lower frequencies than the motor encoder signals, and in Accelnet they are used for commutation-initialization after startup, and for checking the motor phasing after the drive has switched to sinusoidal commutation.

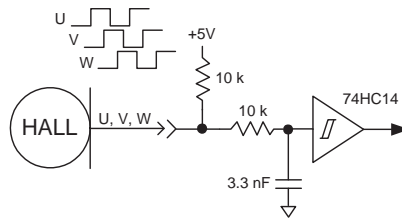

POWER SUPPLIES

Accelnet operates typically from transformer isolated, unregulated DC power supplies. These should be sized such that the maximum output voltage under high-line and no-load conditions does not exceed the drives maximum voltage rating. Power supply rating depends on the power delivered to the load by the drive. In many cases, the continuous power output of the drive is considerably higher than the actual power required by an incremental motion application.

Operation from regulated switching power supplies is possible if a diode is placed between the power supply and drive to prevent regenerative energy from reaching the output of the supply. If this is done, there must be external capacitance between the diode and drive. The minimum value required is 330 µF per drive.

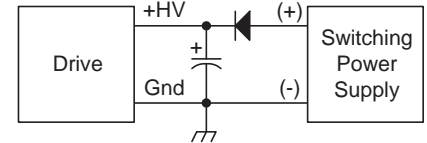

SECONDARY ENCODER

A secondary incremental encoder can be connected to [IN7] and [IN8] for dual-loop position control. A typical use for this would be a gear-motor driving a leadscrew. An encoder on the leadscrew would give the position of the load while the motor encoder and Halls would be used for velocity control and commutation.

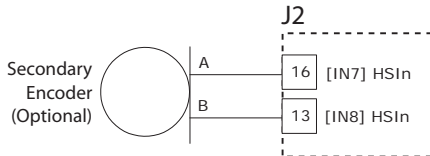

MOTOR PHASE CONNECTIONS

The drive output is a three-phase PWM inverter that converts the DC buss voltage (+HV) into three sinusoidal voltage waveforms that drive the motor phase-coils. The peak voltage between adjacent etches on the PC board is equal to the +HV power, and peak and continuous currents will not be greater than the ratings of the particular drive model. A trace width of 0.175 in, plating thickness of 3 oz copper, and spacing of 0.25 in is adequate for all models of Accelnet.

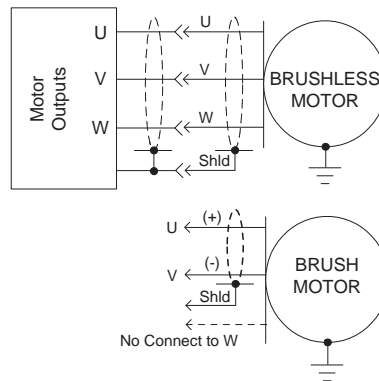

AUX HV INPUT

Accelnet can continue to communicate on a CANopen network under EMO (Emergency Off) conditions if auxiliary DC power is connected to the Aux HV input. This powers the internal DC/DC converter so that motor position and drive communications are preserved while +HV is removed from the PWM inverter stage. The minimum voltage is +20 Vdc, and the maximum is the same as the drive maximum +HV rating. The current requirements will vary with voltage and can be calculated based on an average power consumption of 2.5 W.

RESOLVER (-R MODELS)

Connections to the resolver should be made with shielded cable that uses three twisted-pairs. Once connected, resolver set up, motor phasing, and other commissioning adjustments are made with CME 2 software. There are no hardware adjustments.

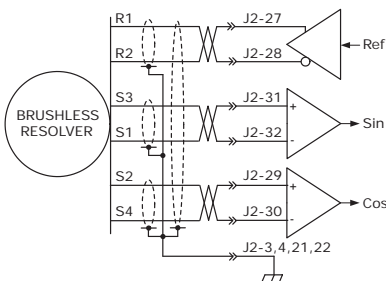

MOUNTING AND COOLING

Accelnet mounts on PC boards using two, dual-row, 0.1 in female headers. These permit easy installation and removal of the drive without soldering. Threaded standoffs swaged into the PC board provide positive retention of the drive and permit mounting in any orientation. Cooling options are: no heatsink and convection heatsinks.

Convection heatsinks are available from Copley in standard, or low-profile forms.

TYPICAL DRIVE CONNECTIONS

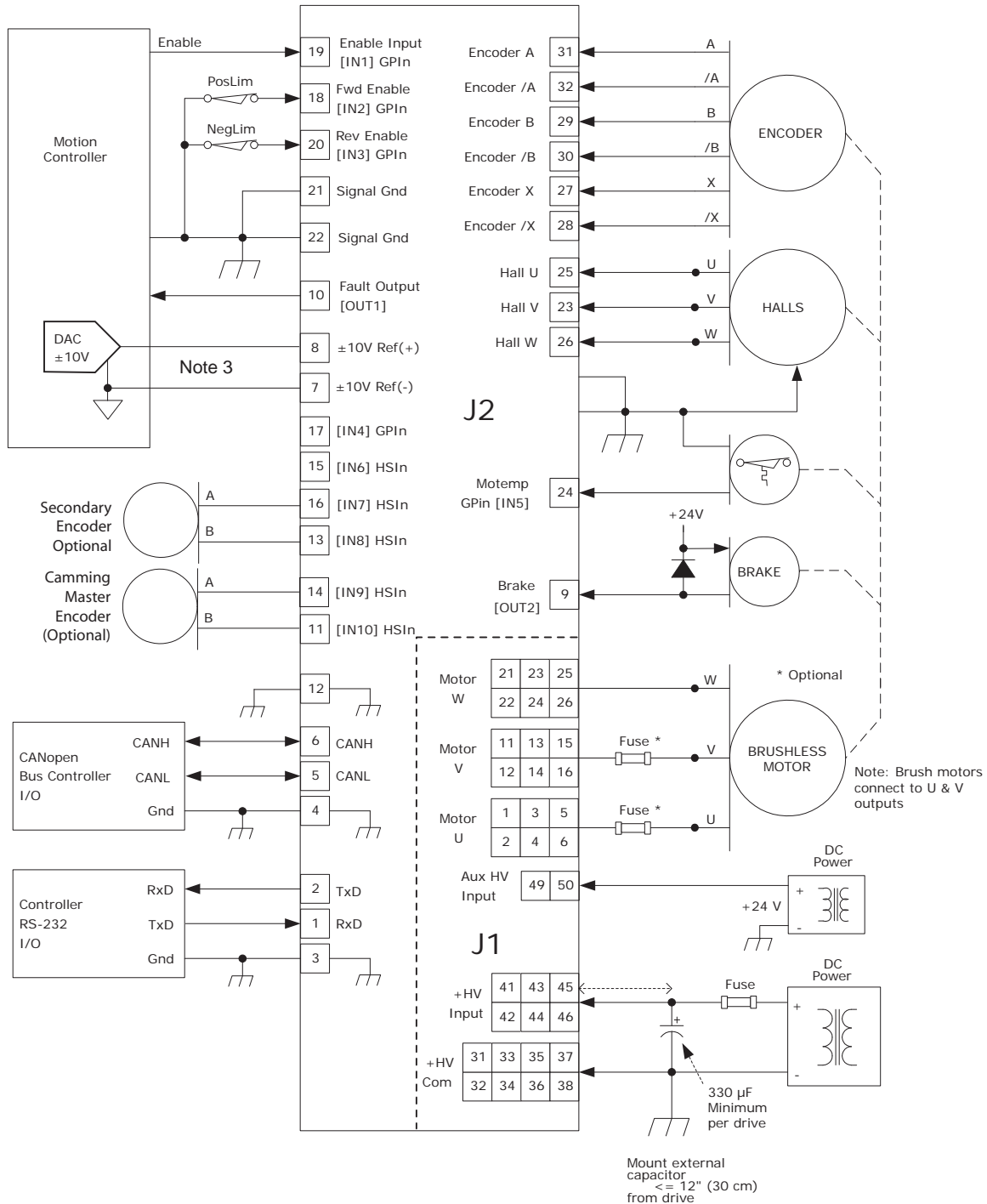

NOTES

- [IN1] always functions as Drive Enable and is not programmable. [IN2]~[IN10] are programmable.
- HS inputs [IN6,7,8,9,10] are for high-speed signals and have 100 ns RC filters. GP inputs [IN1,2,3,5] have 330 µs filters, [IN4] has a 33 µs filter. RC filter time constants apply when inputs are driven by active sources and do not include the 10 kΩ pull-up resistors.
- Analog input only available on RoHS models (green leaf on label)

DRIVE PC BOARD CONNECTORS

J2: Signal
Dual row, 0.1" centers
32 position female header
SAMTEC SSW-116-01-S-D

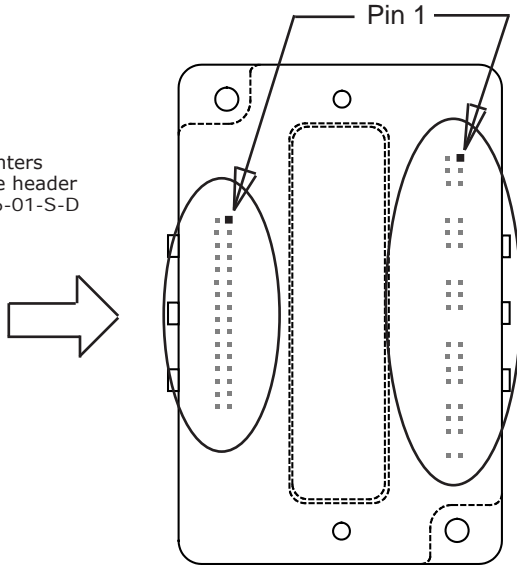

Drive viewed from above looking down on the pc board on which it is mounted.
Pins and housing shapes are shown in phantom view.

J1: +HV, Aux HV, Gnd, & Motor Outputs
Dual row, 0.1" centers
Female header
SAMTEC SSW-125-01-S-D

Signal	J2 Pin	Signal
RS-232 TxD	2	1 RS-232 RxD
Signal Ground	4	3 Signal Ground
CANH	6	5 CANL
±10V Ref(+)	8	7 ±10V Ref(-)
Fault [OUT1]	10	9 [OUT2] Brake
Signal Ground	12	11 [IN10] HSInput
HSInput [IN9]	14	13 [IN8] HSInput
HSInput [IN7]	16	15 [IN6] HSInput
GPInput [IN2]	18	17 [IN4] GPInput
GPInput [IN3]	20	19 [IN1] GPInput
Signal Ground	22	21 Signal Ground
GPInput [IN5]	24	23 Hall V
Hall W	26	25 Hall U
Encoder /X	28	27 Encoder X
Encoder /B	30	29 Encoder B
Encoder /A	32	31 Encoder A

Note 2

Note 2

Signal	J1 Pin	Signal
Motor U	2	1
	4	3
	6	5
No Connection	8	7
	10	9
Motor V	12	11
	14	13
	16	15
No Connection	18	17
	20	19
Motor W	22	21
	24	23
	26	25
No Connection	28	27
	30	29
HV COM (Ground)	32	31
	34	33
	36	35
	38	37
No Connection	40	39
+HV	42	41
	44	43
	46	45
No Connection	48	47
Aux HV	50	49

NOTES

1. Signals are grouped for current-sharing on the power connector. When laying out pc board artworks, all pins in groups having the same signal name must be connected.
2. Analog input only available on RoHS models (green leaf on label)

Resolver

TYPICAL DRIVE CONNECTIONS

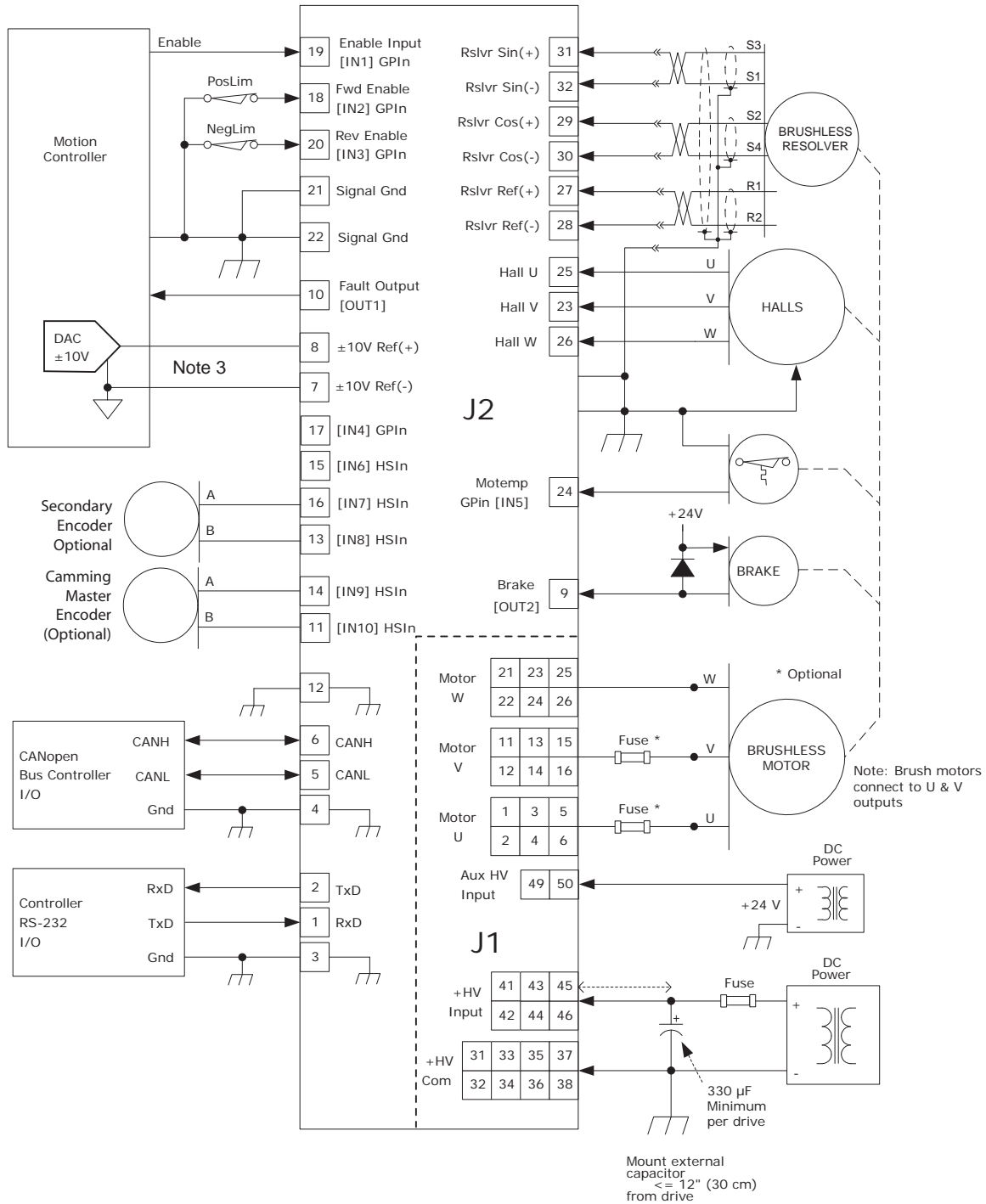

NOTES

- [IN1] always functions as Drive Enable and is not programmable. [IN2]~[IN10] are programmable.
- HS inputs [IN6,7,8,9,10] are for high-speed signals and have 100 ns RC filters. GP inputs [IN1,2,3,5] have 330 µs filters, [IN4] has a 33 µs filter. RC filter time constants apply when inputs are driven by active sources and do not include the 10 kΩ pull-up resistors.
- Analog input only available on RoHS models (green leaf on label)

Resolver

DRIVE PC BOARD CONNECTORS

J2: Signal
Dual row, 0.1" centers
32 position female header
SAMTEC SSW-116-01-S-D

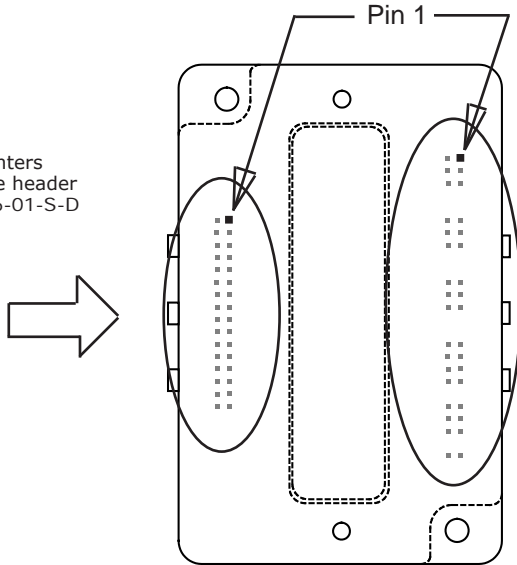

Drive viewed from above looking down on the pc board on which it is mounted.
Pins and housing shapes are shown in phantom view.

J1: +HV, Aux HV, Gnd, & Motor Outputs
Dual row, 0.1" centers
Female header
SAMTEC SSW-125-01-S-D

Signal	J2 PIN	SIGNAL
RS-232 TxD	2	1 RS-232 RxD
Signal Ground	4	3 Signal Ground
CAN_H	6	5 CAN_L
Note 2 ±10V Ref(+)	8	7 ±10V Ref(-) Note 2
Fault [OUT1]	10	9 [OUT2] Brake
Signal Ground	12	11 [IN10] HSInput
HSInput [IN9]	14	13 [IN8] HSInput
HSInput [IN7]	16	15 [IN6] HSInput
GPInput [IN2]	18	17 [IN4] HSInput
GPInput [IN3]	20	19 [IN1] HSInput
Signal Ground	22	21 Signal Ground
GPInput [IN5]	24	23 Hall V
Hall W	26	25 Hall U
Ref(-) Output R2	28	27 Ref(+) Output R1
Cos(-) Input S4	30	29 Cos(+) Input S2
Sin(-) Input S1	32	31 Sin(+) Input S3

Signal	J1 Pin		Signal
Motor U	2	1	Motor U
	4	3	
	6	5	
No Connection	8	7	No Connection
	10	9	
Motor V	12	11	Motor V
	14	13	
	16	15	
No Connection	18	17	No Connection
	20	19	
Motor W	22	21	Motor W
	24	23	
	26	25	
No Connection	28	27	No Connection
	30	29	
HV COM (Ground)	32	31	HV COM (Ground)
	34	33	
	36	35	
	38	37	
No Connection	40	39	No Connection
+HV	42	41	+HV
	44	43	
	46	45	
No Connection	48	47	No Connection
Aux HV	50	49	Aux HV

NOTES

1. Signals are grouped for current-sharing on the power connector. When laying out pc board artworks, all pins in groups having the same signal name must be connected.
2. Analog input only available on RoHS models (green leaf on label)

PC BOARD DESIGN

Printed circuit board layouts for *Accelnet* drives should follow some simple rules:

1. Install a low-ESR electrolytic capacitor not more than 12 inches from the drive. PWM drives produce ripple currents in their DC supply conductors. *Accelnet* drives do not use internal electrolytic capacitors as these can be easily supplied by the printed circuit board. In order to provide a good, low-impedance path for these currents a low-ESR capacitor should be mounted as close to the drive as possible. 330 μ F is a minimum value, with a voltage rating appropriate to the drive model and power supply.
2. Connect J1 signals (U,V,W outputs, +HV, and +HV Common) in pin-groups for current-sharing. The signals on J1 are all high-current types (with the exception of the +24 Vdc Aux HV supply). To carry these high currents (up to 20 Adc peak) the pins

of J1 must be used in multiples to divide the current and keep the current carrying capacity of the connectors within specification. The diagram on page 8 shows the pin groups that must be inter-connected to act as a single connection point for pc board traces.

3. Follow IPC-2221 rules for conductor thickness and minimum trace width of J1 signals. The width and plating should depend on the model of drive used, the maximum voltage, and maximum current expected to be used for that model. Power supply traces (+HV, +HV Common) should be routed close to each other to minimize the area of the loop enclosed by the drive DC power. Noise emission or effects on nearby circuitry are proportional to the area of this loop, so minimizing it is good layout practice.

Motor signals (U,V,W) should also be routed close together. All the motor currents sum to zero, and while the instantaneous value

in a given phase will change, the sum of currents will be zero. So, keeping these traces as closely placed as possible will again minimize noise radiation due to motor phase currents.

Accelnet circuit grounds are electrically common, and connect internally. However, the J1 signals carry high currents while the grounds on J2 (signal ground) carry low currents. So, J2 signals should be routed away from, and never parallel to the signals on J1. Encoder signal pairs (A, /A, B, /B, and X, /X) should be routed close together for good transmission-line effect to reduce reflections and noise.

The drive heatplate is electrically isolated from all drive circuits. For best noise-immunity it is recommended to connect the standoffs to frame ground and to use metal mounting screws to maintain continuity between heatplate and standoffs.

DIMENSIONS

Note: Dimensions shown in inches [mm].

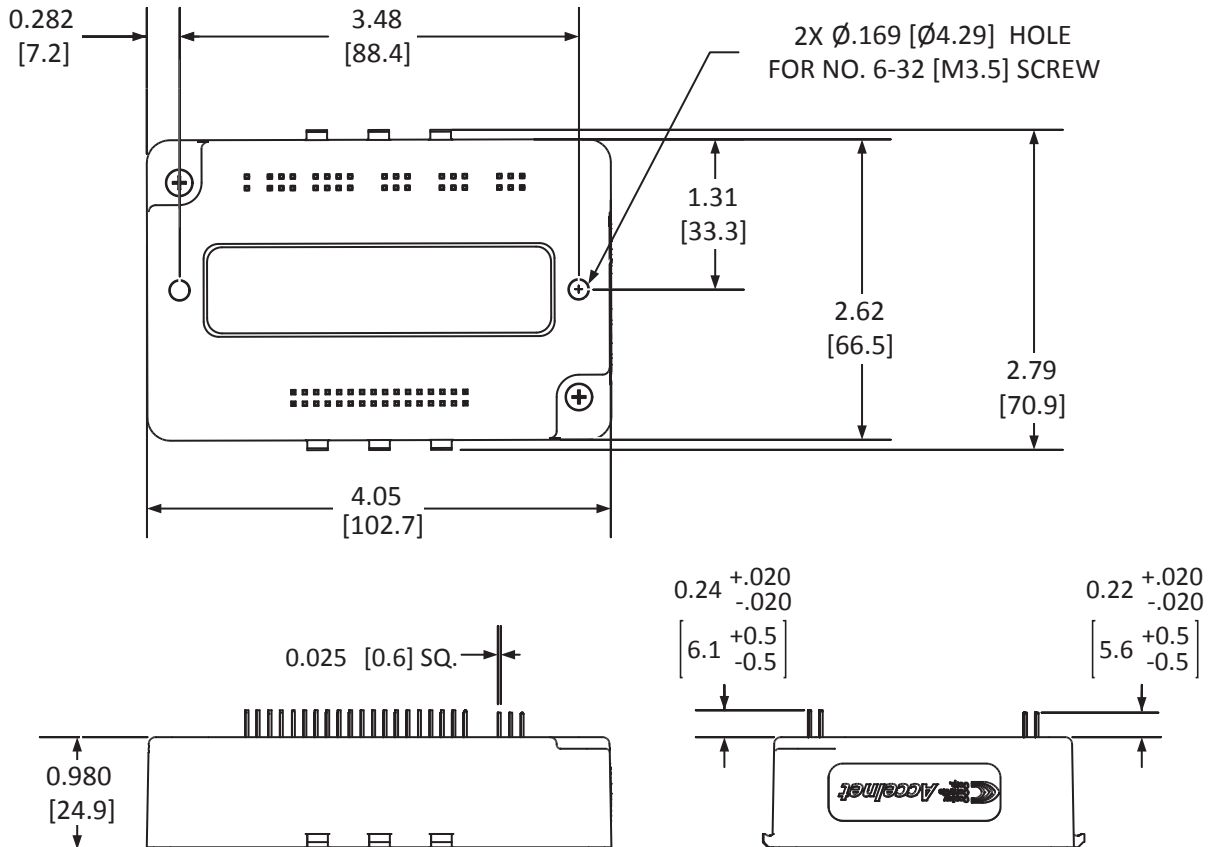

PC BOARD MOUNTING FOOTPRINT

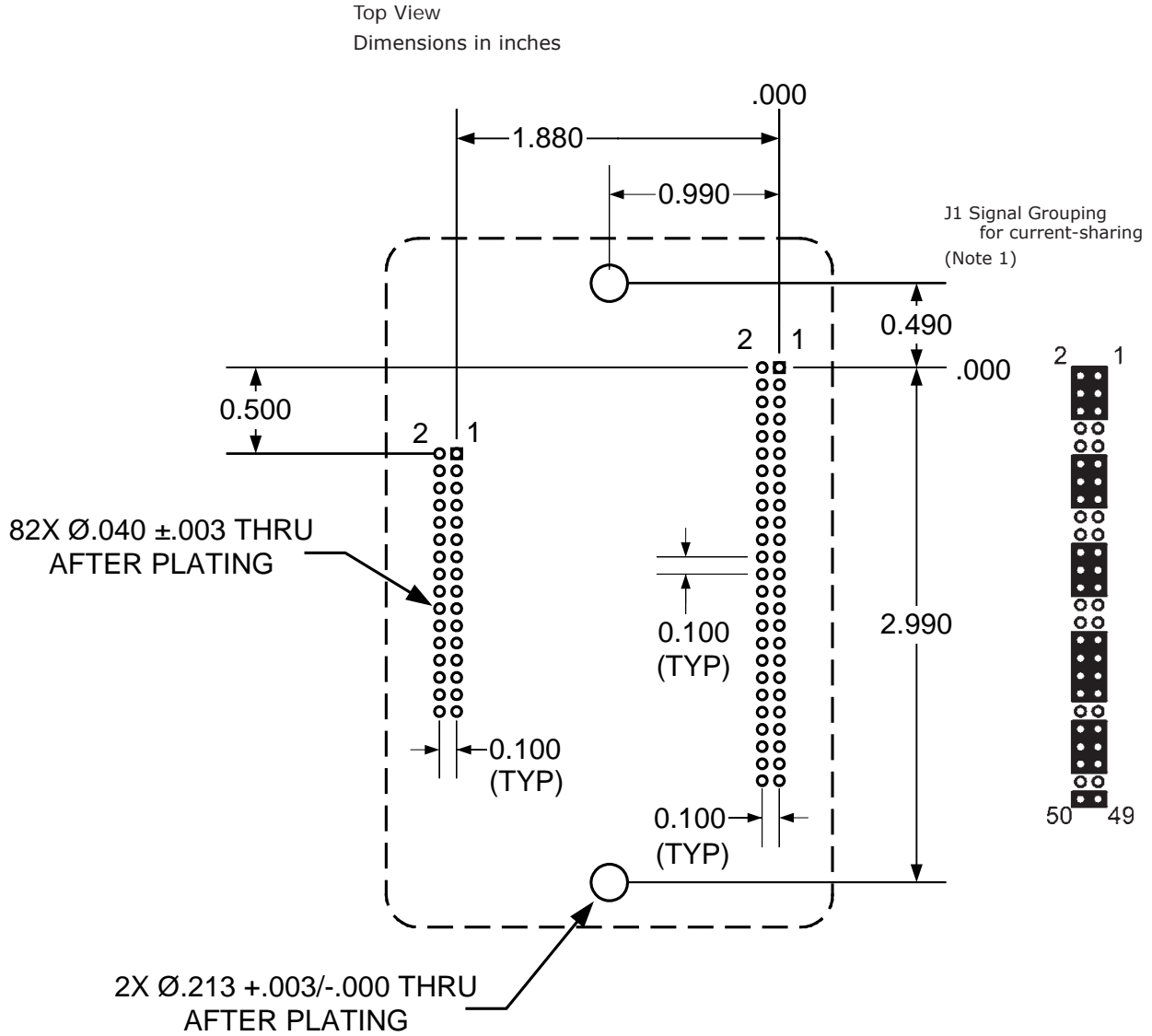

Accelnet Mounting Hardware:

Qty	Description	Mfgr	Part Number	Remarks
1	Socket Strip	Samtec	SSW-116-01-S-D	J2
1	Socket Strip	Samtec	SSW-125-01-S-D	J1
2	Standoff 6-32 X 3/8"	PEM	KFE-632-12-ET	

Notes

- J1 signals must be connected for current-sharing.
- To determine copper width and thickness for J1 signals refer to specification IPC-2221. (Association Connecting Electronic Industries, <http://www.ipc.org>)
- Standoffs should be connected to etches on pc board that connect to frame ground for maximum noise suppression and immunity.

POWER DISSIPATION

The charts on this page show the drive's internal power dissipation for different models under differing power supply and output current conditions. Drive output current is calculated from the motion profile, motor, and load conditions. The values on the chart represent the rms (root-mean-square) current that the drive would provide during operation. The +HV values are for the average DC voltage of the drive power supply.

To see if a heatsink is required or not, the next step is to determine the temperature rise the drive will experience when it's installed. For example, if the ambient temperature in the drive enclosure is 40 °C, and the heatplate temperature is to be limited to 70° C or less to avoid shutdown, the maximum rise would be 70C - 40C, or 30° C. Dividing this dissipation by the thermal resistance of 6.2° C/W with no heatsink gives a dissipation of 4.8W. This line is shown in the charts to the right. For power dissipation below this line, no heatsink is required.

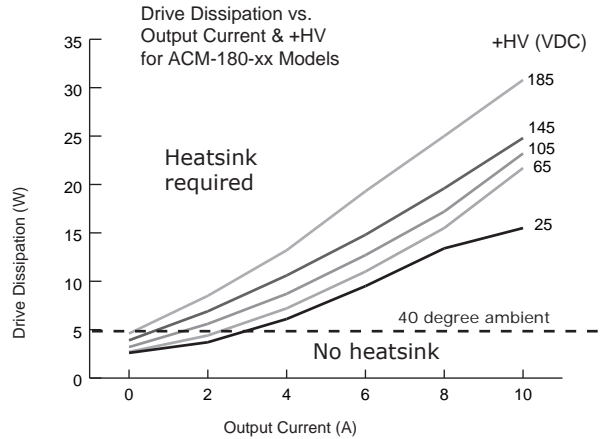
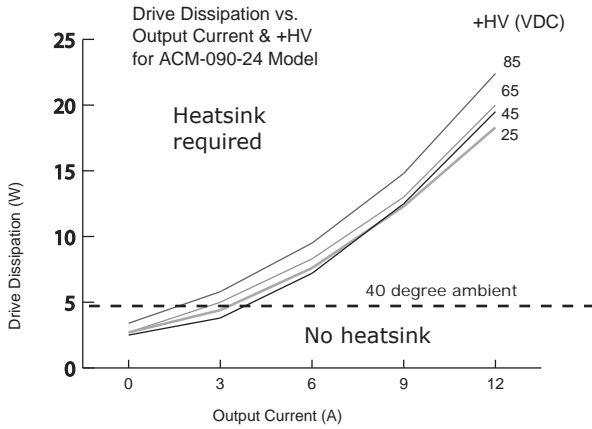
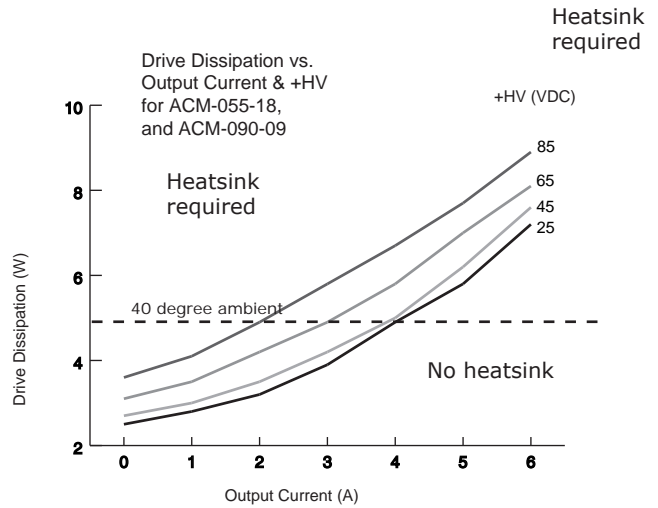

HEATSINK INSTALLATION

If a heatsink is used it is mounted using the same type of screws used to mount the drive without a heatsink but slightly longer. Phase change material (PSM) is used in place of thermal grease. This material comes in sheet form and changes from solid to liquid form as the drive warms up. This forms an excellent thermal path from drive heatplate to heatsink for optimum heat transfer.

STEPS TO INSTALL

1. Remove the PSM (Phase Change Material) from the clear plastic carrier.
2. Place the PSM on the AccelNet aluminum heatplate taking care to center the PSM holes over the holes in the drive body.
3. Mount the heatsink onto the PSM again taking care to see that the holes in the heatsink, PSM, and drive all line up.
4. Torque the #6-32 mounting screws to 8~10 lb-in (0.9~1.13 N·m).

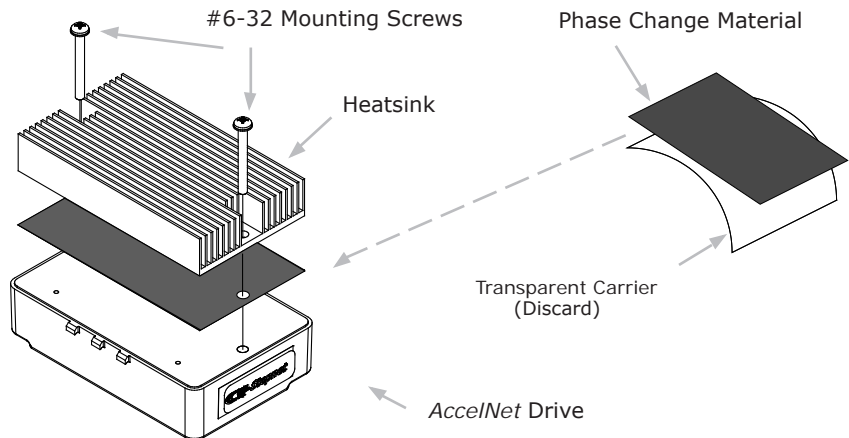

HEATSINK OPTIONS

Rth expresses the rise in temperature of the drive per Watt of internal power loss. The units of Rth are °C/W, where the °C represent the rise above ambient in degrees Celsius. The data below show thermal resistances under convection, or fan-cooled conditions for the no-heatsink, HL, and HS heatsinks, and for the chip-cooler with integral fan.

NO HEATSINK

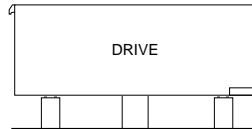
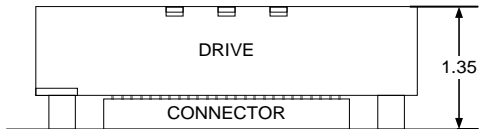

NO HEATSINK	°C/W
CONVECTION	6.2
FORCE AIR (300 LFM)	2.1

LOW-PROFILE HEATSINK (ACM-HL)

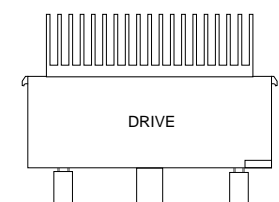
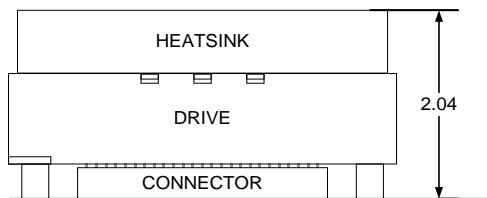

ACM-HL HEATSINK	°C/W
CONVECTION	4.0
FORCE AIR (300 LFM)	0.9

STANDARD HEATSINK (ACM-HS)

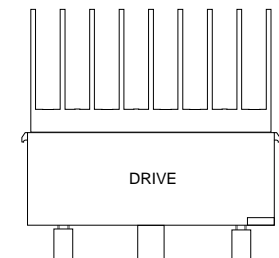
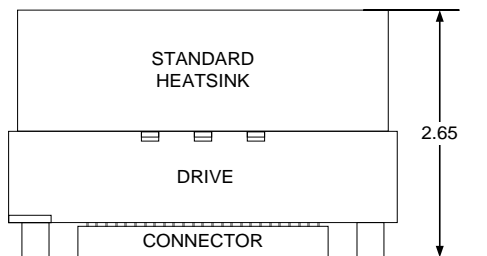

ACM-HS HEATSINK	°C/W
CONVECTION	2.2
FORCE AIR (300 LFM)	0.5

Dimensions in inches
using recommended
connectors and standoffs
(see page 9)

ORDERING GUIDE

PART NUMBER	DESCRIPTION
ACM-055-18	Accelnet™ Servodrive 6/18 Adc @ 55 Vdc
ACM-090-09	Accelnet™ Servodrive 3/9 Adc @ 90 Vdc
ACM-090-24	Accelnet™ Servodrive 12/24 Adc @ 90 Vdc
ACM-180-09	Accelnet™ Servodrive 3/9 Adc @ 180 Vdc
ACM-180-18	Accelnet™ Servodrive 6/18 Adc @ 180 Vdc
ACM-180-20	Accelnet™ Servodrive 10/20 Adc @ 180 Vdc
MDK-180-01	Accelnet™ Development Kit
MDK-CK	Accelnet™ Development Kit Connector Kit
ACM-HL	Accelnet™ Module Heatsink Kit, Low-profile
ACM-HS	Accelnet™ Module Heatsink Kit, Standard
CME2	CME 2™ Drive Configuration Software CD-ROM
SER-CK	Serial Cable Kit

Add -R to part numbers above for resolver feedback

ORDERING INSTRUCTIONS

Example: Order 1 ACM-090-09 drive with Standard Heatsink, Development Kit, and Development Kit Connector Kit

Qty	Item	Remarks
1	ACM-090-09	Accelnet servo drive
1	ACM-HS	Standard Heatsink
1	MDK-180-01	Accelnet Development Kit
1	MDK-CK	Connector Kit for Development Kit
1	CME2	CME2™ CD
1	SER-CK	Serial Cable Kit

NOTES

1. Heatsink kits are ordered separately and installed by the customer, not at the factory.

RoHS COMPLIANCE

ACM models with the green leaf symbol on the label are RoHS compliant and have a ±10 Vdc analog input.

