

- **PCB Mount**
- **Position, Velocity, and Torque Control**
- **Controller Interface**  
Stepper Interface  
±10V Velocity / Torque Command  
PWM Velocity / Torque Command  
Electronic gearing
- **Field-Oriented Control for Optimal Speed / Torque**
- **Auto-Tuning and Auto-Phasing**
- **Feedback**  
Digital Encoder and Halls
- **Programmable I/O:**  
6 inputs, 2 outputs



Model	Ic	Ip	Vdc
ASC-055-18	6	18	55
ASC-090-09	3	9	90

**description**

The *Accelus™* servoamplifier drives DC brushless motors in position, velocity, or torque modes with 100% digital control. Commutation is sinusoidal using encoder feedback from the motor. Hall signals are used for phase-initialization and phase-correction eliminating motor hunting after power-up.

Advanced field-oriented-control ensures the highest motor torque over a wide speed range, minimizing motor heating and maximizing efficiency. Digital control algorithms transform AC stator currents into direct and quadrature components. The torque-producing quadrature current is controlled by the current loop, and the direct component is driven to zero eliminating losses from current that doesn't produce torque. Space-vector modulation produces higher speeds than sine-pwm modulation from the same buss voltage.

*CME 2™* software communicates with *Accelus* through an RS-232 link for complete amplifier setup. Auto-phasing and auto-tuning algorithms in *CME 2™* slash set up times for fast system commissioning and eliminate "re-wire and try" so common in brushless motor installations. *CME 2™* automates current loop tuning, as well as motor, Hall, and encoder phasing. A powerful oscilloscope and signal generator display amplifier performance for fine tuning thereafter. Amplifier control parameters are saved in non-volatile flash

memory. OEM's can inventory one part, and configure amplifiers on-site to each axis in a machine.

*Accelus™* works with motion controllers that close position-loops using incremental encoder feedback and process the position error in a PID filter to produce an amplifier command for torque, force, or velocity. Only one +/-10V analog, or a one or two-wire digital PWM/(DIR) control signal is required. All commutation is done in the amplifier.

In position-mode, *Accelus™* accepts two-wire digital step-motor control signals (CW/CCW, or Count/Direction), or operates as a slave from a master encoder. The ratio between input position pulses and motor position is programmable.

Velocity control is derived from motor encoder signals. Velocity mode is useful not only for speed-setpoint applications, but enables operation with PLC's or controllers that output position-error signals with no PID filtering.

All amplifier circuits are DC coupled and operate from unregulated transformer-isolated DC power supplies, or regulated switching power supplies.

The package is a single board with no heatplate. Solderless mating connectors on pc boards mount *Accelus™* at 0° or 90°. Installation and replacement is fast and doesn't damage amplifier connections. A Development Kit is available that mounts 1~4 *Accelus™* amplifiers and provides unregulated DC power from an isolation step-down transformer.

## GENERAL SPECIFICATIONS

Test conditions: Load = 1mH in series with 1 Ohm. Ambient temperature = 25 deg. C.

MODEL	ASC-055-18	ASC-090-09	
<b>OUTPUT POWER</b>			
Peak Current	18 (12.73)	9 (6.36)	Amps DC (Amps ACrms)
Peak time	1	1	Sec
Continuous current	6 (4.24)	3 (2.12)	Amps DC (Amps ACrms)
<b>INPUT POWER</b>			
HV <sub>min</sub> ~ HV <sub>max</sub>	20 ~ 55 20 6.7	20 ~ 90 10 3.3	VDC, Transformer-isolated ADC (1 sec) peak input current ADC continuous current
<b>PWM OUTPUTS</b>			
Type	3-phase MOSFET inverter, 20 kHz center-weighted PWM, space-vector modulation		
PWM ripple frequency	40 kHz		
<b>COMMUTATION &amp; CONTROL</b>			
Current loop update rate	20 kHz (50 us period)		
Commutation	Sinusoidal, field-oriented control of DC brushless motor		
Phase Initialization	Amplifier initializes in trapezoidal commutation until a Hall transition occurs, then switches to sinusoidal commutation with phase-correction at each Hall signal transition.		
<b>BANDWIDTH</b>			
Current loop, small signal	3 kHz, bandwidth varies with tuning & load inductance		
HV Compensation	HV <sub>min</sub> to HV <sub>max</sub> Changes in HV do not affect bandwidth		
<b>REFERENCE INPUTS</b>			
Analog torque & velocity reference	+/-10VDC, 12 bit resolution	Differential (J1-25, 26)	
Input impedance	66kΩ	Ohm between Ref(+), Ref(-)	
Digital torque & velocity reference (Note 1)	/PWM, /Polarity (Note 1)	PWM = 0~100%, Polarity = 1/0 (J1-21,23) or PWM = 50% +/-50%, no polarity signal required	
Digital position reference (Note 1)	Pulse & Direction CW & CCW A & B Quadrature Encoder	Single-ended digital inputs with 100ns RC filters Maximum pulse or encoder line frequency 1MHz when driven from active-output controllers.	
<b>CONTROL INPUTS (NOTE 1)</b>			
/Enable [IN2]	Amplifier enable. Active level programmable. 10kΩ pull-up to +5V		
/PosEnable [IN3]	Positive direction limit switch. Active level programmable. 10kΩ pull-up to +5V		
/NegEnable [IN4]	Negative direction limit switch. Active level programmable. 10kΩ pull-up to +5V		
/Motemp [IN1]	Motor overtemperature sensor input. Active level programmable. 10kΩ pull-up to +5Vs Disables amplifier when motor over-temperature occurs.		
All inputs	Logic threshold = +2.5V. Maximum input voltage = 32VDC.		
<b>SERIAL DATA INPUT</b>			
RS-232	Rx/D, Tx/D, Gnd in 6-position, 4-contact RJ-11 type modular connector, and on pc board connector J1. Full-duplex, serial communication port for amplifier setup and control, 9600 to 115200 baud		
<b>MOTOR CONNECTIONS</b>			
Phase U, V, W	Amplifier outputs to Wye or delta connected brushless motors		
Hall U, V, W	Digital Hall signals		
Encoder A, /A, B, /B, (X, /X)	Quadrature encoder signals (X or Index signal not required). 5MHz maximum line frequency (20Mcounts/sec).		
/Motemp, /Brake	See Control Inputs (above) and Digital Outputs (below) for details		
<b>STATUS INDICATORS</b>			
Amp Status	Bicolor LED. Amplifier status indicated by color, and blinking or non-blinking condition as follows: Green/Slow-Blinking = Amp OK, will run when enabled Green/Fast-Blinking = Amp enabled but positive or negative limit switch inputs are active Green/Solid = Amp OK and motor will move when commanded (Amp enabled) Red/Solid = Transient fault condition: Over or under voltage, motor over-temperature, or phasing error (current position > 60° electrical from Hall angle) Red/Blinking = Latching fault condition: output or internal short circuit, amplifier over-temperature, position-mode following error.		
<b>DIGITAL OUTPUTS (NOTE 1)</b>			
Fault [OUT1]	Current-sinking MOSFET open-drain output with 1kΩ pullup to +5V through diode, 1A sink max, 30V max. Normally ON (LO). Output turns OFF (HI) when amplifier fault occurs		
/Brake [OUT2]	Current-sinking MOSFET to actuate motor brake. ON when amplifier enabled and operating OFF when amp disabled. ON-state sinks current from motor brake connected to external voltage source such as +24VDC. Current-flow releases brake. External flyback diode required with inductive loads.		
<b>PROTECTIONS</b>			
HV Overvoltage	+HV > Max HV	Amplifier outputs turn off until +HV < Max HV (See Input Power for Max HV)	
HV Undervoltage	+HV < 20VDC	Amplifier outputs turn off until +HV > 20 VDC	
Amplifier over temperature	PC Board > 90° C.	Amplifier latches OFF until Enable input cycled, power off-on, or Reset (Note 1)	
Short circuits	Output to output, output to ground, internal PWM bridge faults		
I <sup>2</sup> T Current limiting	Programmable: continuous current, peak current, peak time		
Motor over temperature	Amplifier shuts down when motor over-temperature switch changes digital input (Note 1)		
<b>MOUNTING &amp; COOLING</b>			
Thermal resistance	3.4 °C/W 0.8 °C/W	PC board to ambient, convection-cooled, 90° mounting PC board to ambient, fan-cooled, 300 linear ft/min.	
Amplifier internal resistance			

## NOTES

1. Digital inputs [IN1], [IN3], [IN4], [IN5], and [IN6] & outputs [OUT1] & [OUT2] have alternate functions (programmable). Default functions are shown here.

## COMMUNICATION

Accelus™ is configured via a three-wire, full-duplex RS-232 port that operates from 9600 to 115,200 Baud. CME 2™ provides a graphic user interface (GUI) to set up all of Accelus features via a computer serial port. Connections to the Accelus™ RS-232 port P1 are via an RJ-11 style connector, and through the pc board connector J1 (J1-19 & 20). Rx/D, Tx/D, and Gnd signals comprise the signals supported. The Accelus™ Serial Cable Kit contains a modular cable, and an adapter that connects to a 9-pin, Sub-D serial port connector (COM1, COM2, etc.) on PC's and compatibles.

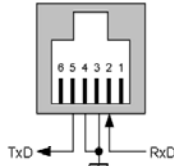

## STATUS LED

A single bi-color LED gives the state of the amplifier by changing color, and either blinking or remaining solid. Slow-blinking is about 1 blink/sec, fast is about 5 blinks/sec. The possible color and blink combinations are:

- **Green/Solid:** Amplifier OK AND enabled. Will run in response to reference input.
- **Green/Slow-Blinking:** Amplifier OK but NOT-enabled. Will run when enabled.
- **Green/Fast-Blinking:** Positive or Negative limit switch active. Amplifier will only move in direction not inhibited by limit switch.
- **Red/Solid:** Temporary fault condition. Amplifier will resume operation when fault is removed.
- **Red/Blinking:** Latching fault. Operation will not resume until amp is Reset

Temporary fault conditions: Over or under-voltage, motor over-temperature, phase error (current position > 60° electrical from Hall angle).  
Latching fault conditions: Short-circuits from output to output, output to ground, and internal shorts or over current conditions, amplifier over-temperature, or position-mode following error.

## DIGITAL INPUTS

There are four digital inputs that control the "enable" state of the amplifier: [IN1], [IN2], [IN3], and [IN4]. Each input has a 10k resistor that connects to +5V and so are "pull-up" inputs that work with grounded

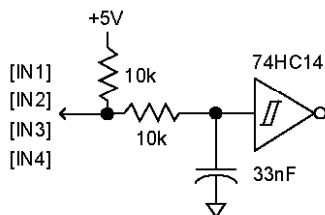

switches, open-collector, CMOS, or TTL outputs.

[IN2] always functions as the Enable input, and controls the ON/OFF state of the amplifier outputs. [IN2] can function simply as the amp-enable or as the amp-enable with reset. With the reset options selected, the amplifier will reset when [IN2] goes from the active to the inactive level. The default selection is active-LO with no reset. This setting is the fail-safe condition. In order to make the amplifier operate, the enable input must be connected and must be grounded to operate the amplifier. If a wire were to break, or the controller malfunction, the input would not be grounded and the amplifier would not operate. If the input is set to Active-HI, it is not in a fail-safe mode, and will be enabled with no connection to the [IN2] input. This setting is therefore not recommend for general operation.

The other digital enable inputs, [IN1], [IN3] and [IN4] have alternate functions that are settable via CME 2™:

- Positive Limit Switch
- Negative Limit Switch
- Amplifier Reset
- Motor temp sensor

In addition to the alternate functions, the active level for each input is individually programmable.

Amplifier reset takes place on transitions of the input and is programmable to 1/0 or 0/1. The motor temp sensor function will disable the amplifier if a switch in the motor opens or closes when the motor overheats. The motor temperature switch or sensor should be grounded. The active-level setting is then set depending on the type of switch: normally open, or normally closed.

## DIGITAL OUTPUTS

Digital outputs are open-drain MOSFETs with 1k pull-up resistors to +5V. These can sink up to 1A from external loads operating from power supplies to 30V. When driving inductive loads such as a motor brake, an external fly-back diode is required. A diode in the output is for driving PLC inputs that are opto-isolated and connected to +24V. The diode prevents conduction from +24V through the 1k resistor to +5V in the amplifier. This could turn the input on, giving a false indication of the amplifier output state.

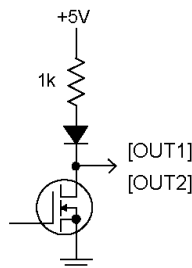

## REFERENCE INPUTS

The Reference input is the one that commands the amplifier to produce an output. Accelus™ has analog and digital reference inputs. Only one can be active at a time.

## ANALOG REFERENCE INPUT

The analog ±10V signal is an industry standard for torque or velocity control. The analog reference input is a differential amplifier which is to be connected to the motion controller ground and DAC output. Using a differential amplifier is important because there may be potential differences between the amplifier and controller grounds. A differential amplifier rejects these differences and measures the controller output referenced to ground at the controller.

The voltage *between* Ref(+) and Ref(-) inputs must be zero to produce a "zero" amplifier output. Because the reference amplifier is connected to +1.5V internally, grounding Ref(-), and allowing Ref(+) to be open will produce a large command, as will grounding Ref(+) and letting Ref(-) be open. *When wiring the controller DAC output to the reference inputs, be sure to use both reference inputs, and connect Ref(-) to ground at the controller, and not at the amplifier.*

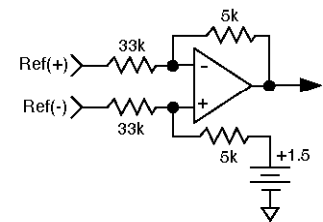

## IMPORTANT!

**ALWAYS CONNECT BOTH ANALOG REF INPUTS.**

**THERE MUST BE ZERO VOLTS BETWEEN REF(+) & REF(-) FOR ZERO OUTPUT FROM THE AMPLIFIER!**

## DIGITAL REFERENCE INPUTS

These are two logic inputs for digital reference signals that are programmable for controlling torque, velocity, or position. If these inputs are not used as reference inputs, they are programmable for the same functions as [IN1], [IN3], and [IN4]. The electrical structure of these inputs is shown below:

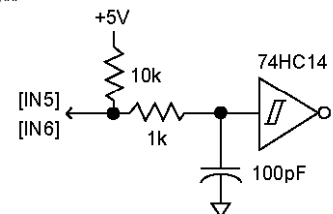

## DIGITAL REFERENCE INPUTS (CONT'D)

For torque or velocity control, the inputs may be configured in two formats:

1. PWM (0~100%) & Polarity
2. PWM (50%)

In the first case, the PWM signal can vary from 0% to 100%, and the Polarity signal is a DC level that controls the direction of the motor. The PWM duty-cycle controls the amplifier output current, or motor velocity. In current mode, 100% corresponds to the maximum output current. In velocity mode, it commands the maximum velocity that is configured.

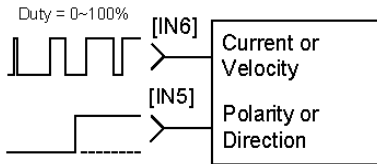

Another type of PWM input is the "50%" type. There is only one PWM signal that connects to IN6. The other digital input IN5 is not used in this mode. A 50% duty-cycle corresponds to a zero-current command in torque mode, or a zero-speed output in velocity mode.

Duty-cycles of 0%, and 100% would result in negative full-scale, or positive full-scale outputs. So, the duty-cycle controls not only the magnitude, but also the polarity of the amplifier outputs.

The scale-factor for amplifier-output vs. PWM inputs is settable via *CME 2™* software in both cases.

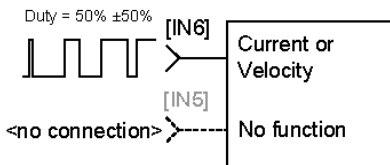

When operating *Accelus™* in position mode, the digital reference inputs accept step-motor pulses in two formats, or quadrature-encoder signals. In either case, the ratio between input pulses, and motor encoder counts is programmable.

The first format of stepper-command signals is the CW/CCW (clockwise/counterclockwise) format, which could also be called CU/CD (count-up/count-down). Pulses at IN6 will increase the position-command to the amplifier, and pulses at IN5 will decrease it. The other stepper-command format is the Pulse & Direction one where pulses at IN6 will increment or decrement the position-command depending on the DC level at the Direction input, IN5.

Digital reference inputs configured as CW/CCW inputs in position mode:

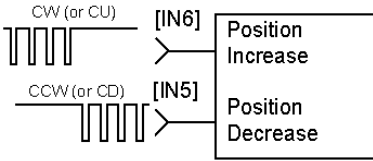

Digital reference inputs configured as Pulse-Direction inputs in position mode:

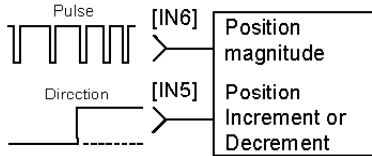

Digital reference inputs can also connect to a quadrature encoder that outputs two pulse trains corresponding to angle of rotation, or linear travel. The pulse trains are phase-shifted 90° which gives them the name "quadrature", and each time one changes, the amplifier can interpret the change as an incremental position command. The amplifier decodes the A and B channel signals to determine if it is an increase, or decrease in position. If the encoder is mounted on a motor that is controlled by another amplifier and controller, it is referred to as "master-slave" operation. The master in this case is the motor controlled externally, and the *Accelus™* is the slave, following the position of the master in a ratio that is configurable via *CME 2™*.

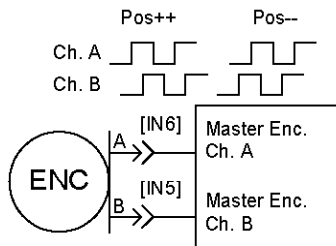

## MOTOR CONNECTIONS

Motor connections are of three types: phase, Halls, and encoder. The phase connections carry the amplifier output currents that drive the motor to produce motion. The Hall signals are three digital signals that give absolute position feedback within an electrical commutation cycle. The encoder signals give incremental position feedback and are used for velocity and position modes, as well as sinusoidal commutation.

## MOTOR ENCODER

The input circuit for the motor encoder signals is a differential line-receiver with R-C filtering on the inputs. The circuit is shown below. Encoders with differential outputs are preferred because they are less susceptible to noise that can be picked on single-ended outputs. For best results, encoder cabling should use twisted pair cable with one pair for each of the encoder outputs: A-/A, B-/B, and X-/X. Shielded twisted-pair is even better for noise rejection. PC board layouts should route the encoder signal-pairs as close to each other as possible for best transmission-line characteristics. If single-ended encoders are used, the unused input can be left open. It is recommended that the inverting input be left open as its' open-circuit voltage of 2.0V (typical) is closer to TTL and CMOS levels than the non-inverting input which has an open-circuit voltage of 2.9V (typical). The encoder input circuit is shown below.

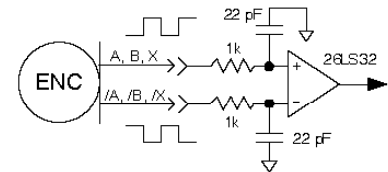

## MOTOR HALL SIGNALS

Hall signals are single-ended signals that provide absolute feedback within one electrical cycle of the motor. There are three of them (U, V, & W) and they may be sourced by magnetic sensors in the motor, or by encoders that have Hall tracks as part of the encoder disc. They typically operate at much lower frequencies than the motor encoder signals, and in *Accelus™* they are used for commutation-initialization after startup, and for checking the motor phasing after the amplifier has switched to sinusoidal commutation following the to sinusoidal commutation after startup.

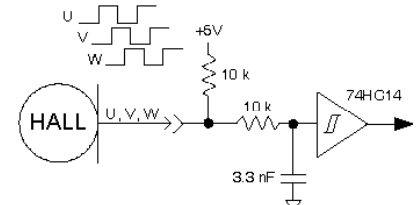

## MOTOR PHASE CONNECTIONS

The amplifier outputs connect to a three-phase PWM inverter that converts the DC buss voltage (+HV) into three sinusoidal voltage waveforms that drive the motor phase-coils. The three phase currents I<sub>u</sub>, I<sub>v</sub>, and I<sub>w</sub> sum to zero, so cabling to the motor, and pc board routing should keep



the phase conductors near to each other to maximize transmission-line effects, and to reduce noise coupling into adjacent circuitry. Motor cabling should use twisted, shielded conductors for best shielding and to minimize PWM noise coupling into other circuits. The motor cable shield should connect to motor frame and the amplifier high-current ground terminal (HV return) for best results.

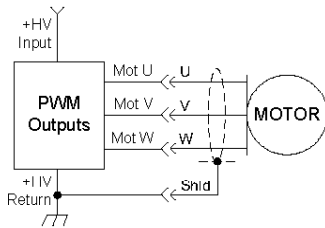

### GROUNDING AND PC BOARD DESIGN

All circuits in *Accelus™* share a common circuit-ground (Signal Gnd on J1, and HV Return on J2). Both of these grounds must connect to user circuit-ground when the amplifier is installed on pc boards. However, there are two paths for current-flow in the amplifier and this must be taken into consideration when pc board layouts are designed. High-current paths are through the +HV and HV Return connections for power-supply currents, and low-current paths are through the I/O signals and Signal Ground.

Because current flow through conductors produces voltage-drops across them, it is best to connect the amplifier HV Return to system-earth, or user circuit-common through the shortest path, and to leave the power-supply floating. In this way, the power supply (-) terminal connects to ground at the amplifier HV Return terminals, and the voltage drops across the traces will not appear at the amplifier ground, but at the power supply negative terminal where they will have less effect.

Motor phase currents are balanced, but currents can flow between the PWM outputs, and the cable shield. To minimize the effects of these currents on nearby circuits, the cable shield should connect to HV Return by the shortest path on the pc board. The maximum continuous current of *Accelus™* is 6 Arms. Using a 25% design margin increases this to 7.5Arms. For a temperature rise of 20° C. an etch width of 60 mils (1.52 mm) is a good minimum value when 2 oz. plating is used. or 40 mils (1.02 mm) for 3 oz. copper. Wider traces lower impedance and minimize noise when used with ground planes.

Amplifier I/O signals are based on +5V

supplies in user equipment. These power supplies should also connect to the HV Return at a single point.

The final configuration should embody three current-carrying loops. First, the power supply currents flowing into and out of the amplifier at the +HV and HV Return pins. Second the amplifier outputs driving currents into and out of the motor phases, and motor shield currents circulating between outputs and HV Return. And, lastly, logic and signal currents connected to the amplifier control inputs and outputs. To minimize noise, these three loops should connect at one point, or at nearby points, and the etch routings in each loop should be isolated from the other loops to minimize interaction and noise pickup.

### POWER SUPPLIES

*Accelus™* operates typically from transformer-isolated, unregulated DC power supplies. These should be sized such that the maximum output voltage under high-line and no-load conditions does not exceed the amplifiers maximum voltage rating. Power supply rating depends on the power delivered to the load by the amplifier. In many cases, the continuous power output of the amplifier is considerably higher than the actual power required by an incremental motion application.

Operation from regulated switching power supplies is possible if a diode is placed between the power supply and amplifier to prevent regenerative energy from reaching the output of the supply.

External capacitance is required when installing *Accelus™*. This should be a minimum of 330 uF per amplifier, to handle ripple currents produced by the PWM switching, and the actual value should be sufficient to control power supply ripple to a level such that the minimum voltage required to drive the load is maintained.

### FUSING & PROTECTIONS

Fusing of input power connections to *Accelus* protects external circuits from an uncontrolled failure of the amplifier. Fusing of motor phase connections provides protection of the motor from overcurrents due to either mis-configuration of the amplifier, or uncontrolled failure of the amplifier. Motor phase fusing is recommended for linear motor applications as this type of motor has a lower thermal capacity, in general, than rotary motors due to the mounting of the phase coils in epoxy 'fins'. This factor, plus the higher cost factors associated with linear motor installations (mounting and accessibility, time to repair, initial cost) make the use of phase-fuses advisable as the ultimate protection for such motors. In many applications, *Accelus™* will have peak and continuous ratings greater than the motors' ratings, so operator errors during setup or adjustments can easily damage the motor with little stress to the amplifier.

The maximum input current to the amplifier will not exceed its rated output currents under normal operating conditions. A time-delay fuse, 1/4" x 1 1/4" with an 8A/125V rating should carry 75% of its' rating continuously, and will trip at 10~20 secs at 18A. This is greater than the 1 sec. peak time of the amplifiers peak current of 18A, indicating that this fuse should provide input power protection for the amplifier.

Depending on the application, fast-acting fuses may be the fuse of choice for motor phase protection. Typically, two fused provide sufficient protection for currents flowing into and out of the amplifier. If grounding of the motor winding is possible, then three fuses would provide complete protection for any overcurrents flowing out of the amplifier and into the motor.

Sizing of motor phase fuses should take into account the peak current, rms current over the anticipated duty cycle of the motor, and motor ratings. The final value selected should be tested in the equipment to prove that no false-tripping occurs under worst-case temperature and operating-current conditions.

AMPLIFIER CONNECTIONS

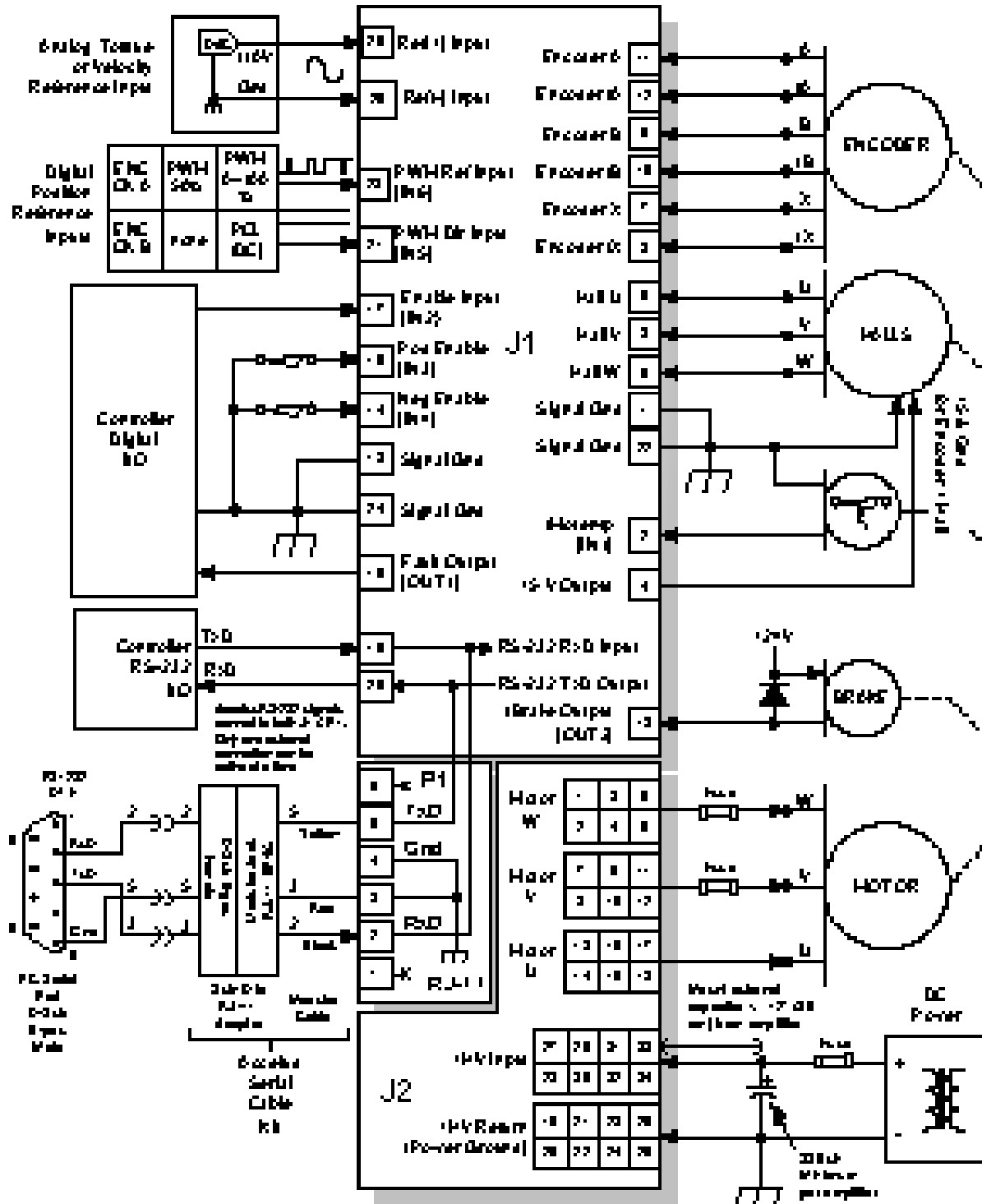

Notes

1. The functions of input signals on J1-2, 14, 16, 21, & 23 are programmable. Default functions are shown.
2. The functions of output signals on J1-13 & 15 are programmable. Default functions are shown.

### AMPLIFIER CONNECTORS

J1 = 26 position, DIL, 0.100" grid, male, .025" square pins  
 J2 = 34 position, DIL, 0.100" grid, male, .025" square pins  
 P1 = 6 position, 6 contact RJ-45 socket, AMP 555077-1

### PC BOARD MATING CONNECTORS

J1 = 26 position, DIL, 0.100" grid, female receptacle  
 Samtec SSW-113-01-S-D-LL, or equivalent  
 J2 = 34 position, DIL, 0.100" grid, female receptacle  
 Samtec SSW-117-01-S-D-LL, or equivalent

**CAUTION!**

J2 connections are made to *groups* of pins for current-sharing. All pins in a group must be connected when laying out pc boards.

Do not connect to single pins for signals in this group. This will exceed current rating of individual pins.

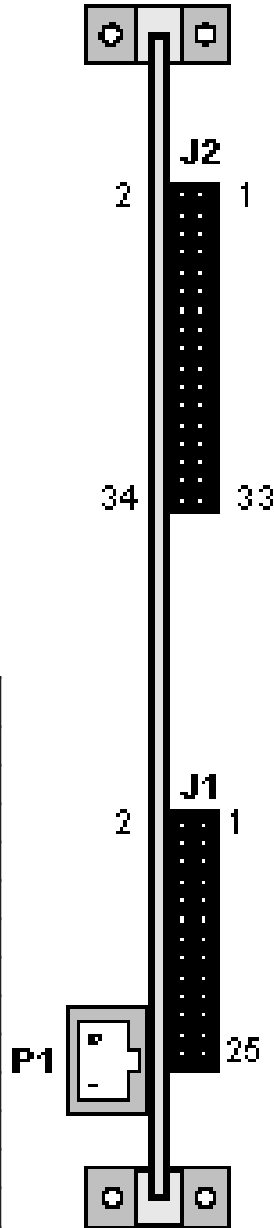

PIN		J2 SIGNAL
2	1	Motor Phase W
4	3	
6	5	
8	7	Motor Phase V
10	9	
12	11	
14	13	Motor Phase U
16	15	
18	17	
20	19	+HV Return (Power Ground)
22	21	
24	23	
26	25	+HV Input
28	27	
30	29	
32	31	
34	33	

J1 SIGNAL	PIN
Motor Temp Sensor Input [IN1]	2
+5V @ 200 mA Output	4
Motor Hall W	6
Encoder /X (/Index)	8
Encoder /B	10
Encoder /A	12
Neg Enable Input [IN4]	14
Pos Enable Input [IN3]	16
Signal Ground	18
RS-232 TxD Output	20
Signal Ground	22
Signal Ground	24
+/-10V Ref Input	26

PIN	J1 SIGNAL
1	Signal Ground
3	Motor Hall V
5	Motor Hall U
7	Encoder X (Index)
9	Encoder B
11	Encoder A
13	[OUT2] Motor Brake Output
15	[OUT1] Fault Output
17	[IN2] Enable Input
19	RS-232 RxD Input
21	[IN5] Direction Input
23	[IN6] PWM Ref Input
25	+/-10V Ref Input

**Notes**

1. The functions of input signals on J1-2, 14, 16, 21, & 23 are programmable. Default functions are shown.
2. The functions of output signals on J1-13 & 15 are programmable. Default functions are shown.

## DIMENSIONS

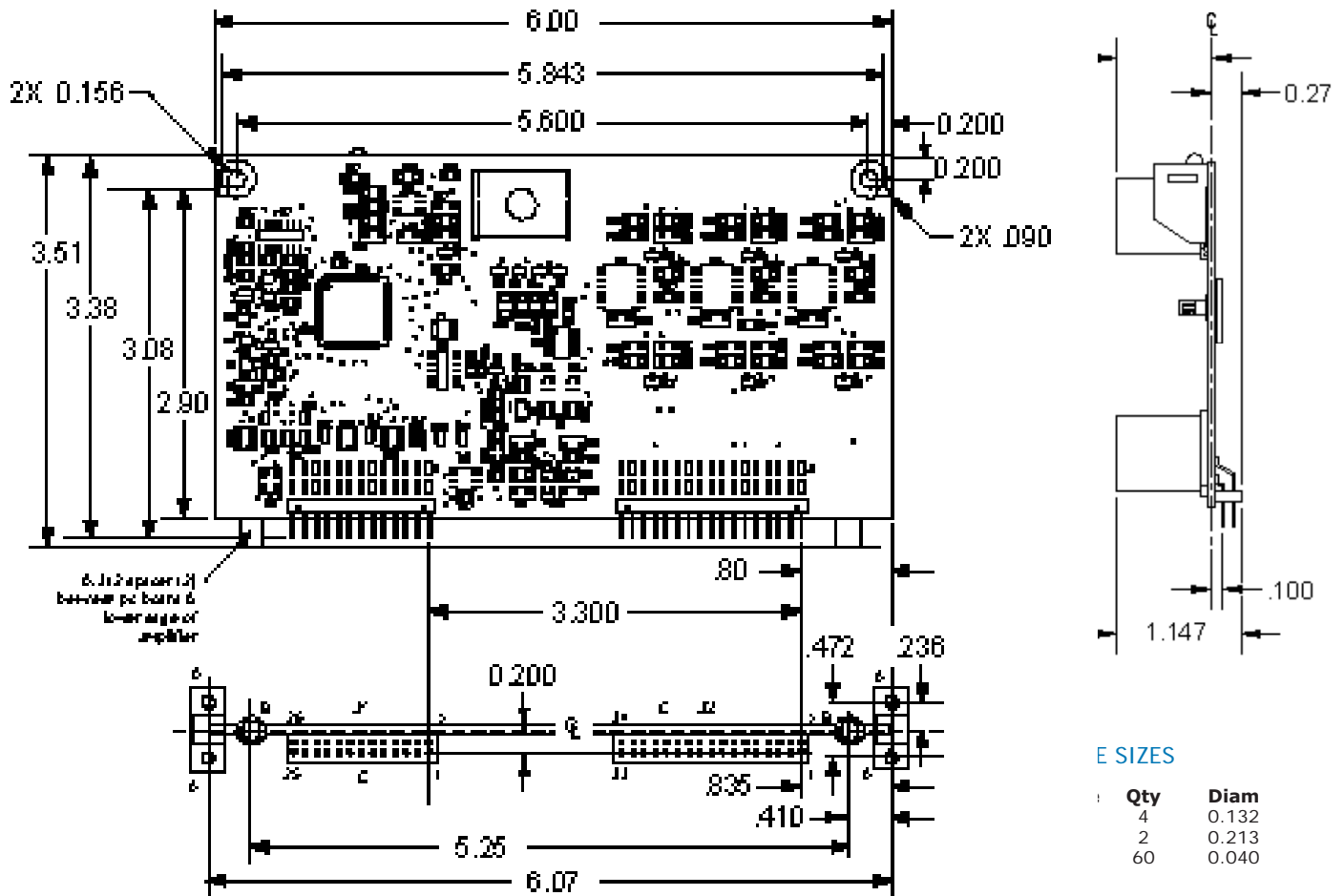

### NOTES

- Dimensions shown in inches.
- Connectors are dual row, 0.100" spacing.  
For 90° mounting:  
J1 = 26 position, SAMTEC SSW-113-06-S-D-LL, or equivalent  
J2 = 34 position, SAMTEC SSW-117-06-S-D-LL, or equivalent
- Standoffs are 0.312" height and are required for positive stop of pc board to prevent excessive force on J1 & J2 during insertion.  
RAF #1534-C-6-A or equivalent
- Card guides for 90° mounting:  
Richco #VMCG-90-PM

## ORDERING GUIDE

Part Number	Description
ASC-055-18	Accelus servo amplifier 6/18 Adc @ 55 Vdc
ASC-090-09	Accelus servo amplifier 3/9 Adc @ 90 Vdc

## ORDERING INSTRUCTIONS

The Development Kit comprises the PC board assembly only. Amplifiers, connector kits, and CD must be ordered separately.

Example: For an SDK with two *Accelus™* Card Servoamplifiers, order the following:

Qty	Item	Remarks
1	SDK-090-04	<i>Accelus™</i> Development Kit
2	ASC-055-18	<i>Accelus™</i> Card Servoamplifier
2	SDK-CK	Connector Kits
1	SER-CK	Serial Cable Kit
1	CME2	<i>CME2™</i> CD