

## HPLA Series Belt Driven Linear Modules

### Features

- Strong – steel roller bearing option for highest load capacity – 1530 kg
- Rugged construction for heavy duty applications
- Thrust force capacity to 5455 N
- Standard travel up to 9 meters
- Velocity up to 5 meters/sec.
- Positional repeatability of  $\pm 0.2$  mm
- Timing belt and pulley drive mechanism for fast, accurate positioning

### The Modular Concept

Provides the ideal solution for applications:

#### Modular drive system:

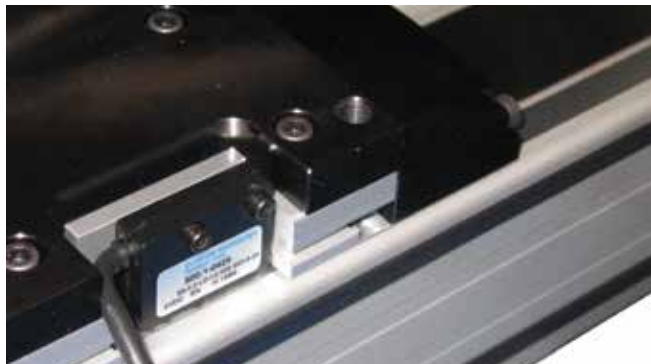
- Increased system stiffness due to larger belt width
- Low maintenance
- High performance due to hollow shaft input

#### Modular guide system:

- Provides an alternative to composite wheel material
- Quiet operation
- Low maintenance
- Steel wheel option on an integrated steel rolling surface for increased load capacity
- High load-bearing capacity
- High levels of rigidity

#### Various options for adaptation to wide ranging applications:

- Steel cover strip
- Corrosion-resistant stainless steel version for application in clean rooms or in the food industry
- Integrated position feedback system for maximum precision
- Optional IP30 rated strip seal



*HPLA Encoder Option*

**See pages 272-276 for available options and accessories.**



### Proven Technology

- Direct mounting for planetary gear reducers – eliminating complexity of additional machined parts or couplings
- Adjustable “end of travel” limit switches and “Home” position sensor
- Cable carrier systems
- Performance matched Parker servo systems
- Structural components for vertical and multi-axis mounting
- Toe clamps and hardware for fast/easy mounting
- External bumper option
- Link shafts and support bearing for dual unit axes
- Splice plates for extending travels beyond length available in a single profile

### Typical Fields of Application

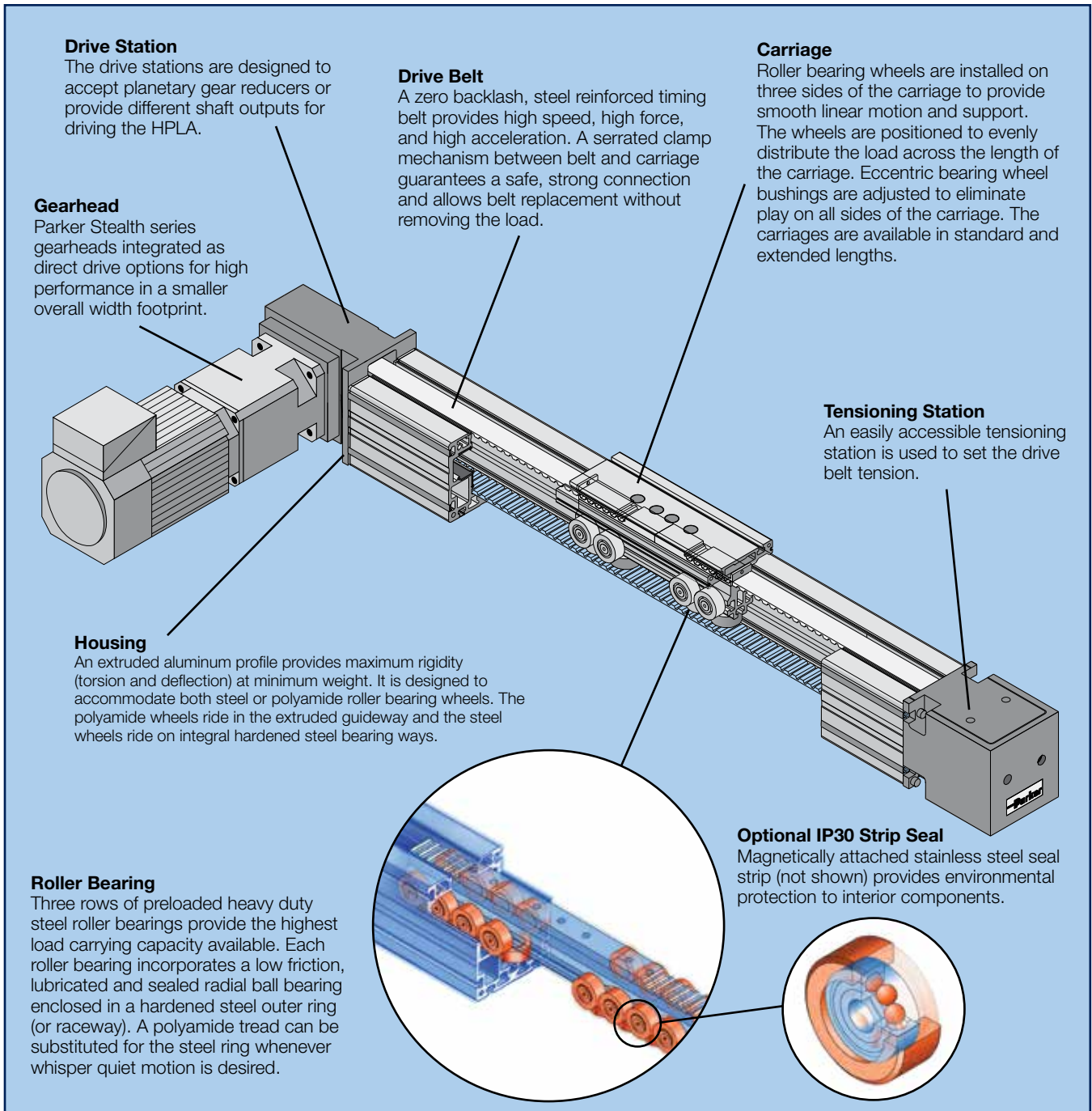
As part of advanced, cost-effective construction of machines and handling systems:

- Materials handling: palletizing, depalletizing, feeding, part removal
- Cleanroom technology: wafer transport, wafer coating
- Warehouse technology: parts picking, storage and retrieval
- Machine tool automation: workpiece loading and unloading, tool changing
- Construction: formwork, placing reinforcing steel bars in concrete
- Process engineering: painting, coating, bonding
- Testing technology: guiding ultrasonic sensors, laboratory equipment
- Textile machinery building: cross-cutting, slitting and stacking, quilting, seam stitching



The HPLA is a rugged “next generation” linear module that offers high speed, high acceleration, and long travel, combined with stiff, rigid construction characteristics. It is ideally suited as a single axis product or as a component for high speed multi-axis gantries. The HPLA carriage is rigidly supported on three sides by heavy duty roller bearings, housed in a rugged aluminum housing. The bearing wheels are pre-loaded via eccentric bushings to eliminate play in the system, and are strategically located to evenly distribute the load across the length of the carriage.

A high strength steel reinforced drive belt and pulley system provides fast and highly repeatable positioning of the carriage. This high thrust drive belt is securely connected to the carriage by a unique clamping system. This system provides a secure connection and enables easy belt replacement without the need to remove the payload. Having a low coefficient of friction, the carriage design provides a high mechanical efficiency and long service life. Special carriage lengths and linear units with multiple carriages are available for custom applications.



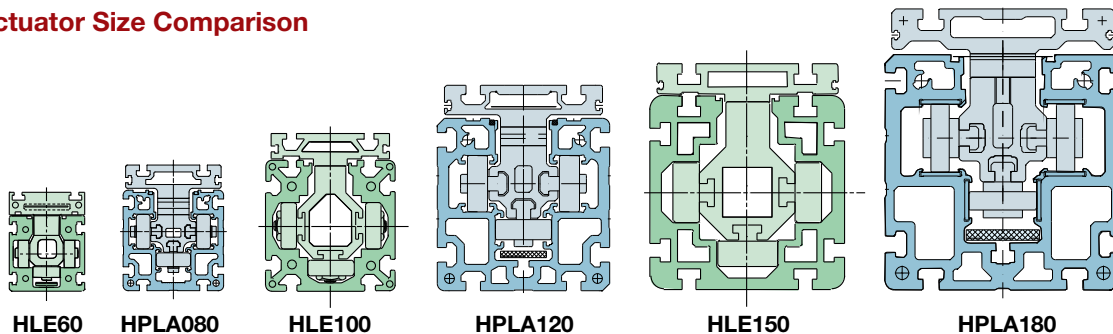
Belt Driven Tables

**HPLA Series Specifications**

Characteristic	Units	HPLA80		HPLA120		HPLA180		HPLA180 (Rack Drive)
		Polyamide Wheel	Steel Wheel	Polyamide Wheel	Steel Wheel	Polyamide Wheel	Steel Wheel	Polyamide Wheel
<b>Unit Weight (basic unit without stroke)</b>								
Standard Carriage, NL	kg (lb)	6.8 (15.0)	7.5 (16.5)	20.2 (44.4)	21.6 (47.5)	57.2 (125.8)	61.6 (135.3)	78.4 (172.5)
Extended Carriage, VL	kg (lb)	8.6 (18.9)	9.5 (20.9)	25.2 (55.4)	27.1 (59.6)	74.8 (164.6)	80.9 (178.0)	95.2 (209.4)
<b>Carriage Weight</b>								
Standard Carriage, NL	kg (lb)	1.7 (3.7)	1.8 (4.0)	5.8 (12.8)	6.0 (13.2)	12.3 (27.1)	12.6 (27.7)	32.5 (71.5) <sup>(1)</sup>
Extended Carriage, VL	kg (lb)	2.6 (5.7)	2.8 (6.2)	8.8 (19.4)	9.2 (20.2)	21.1 (46.4)	21.8 (48.0)	39.8 (87.6) <sup>(1)</sup>
Weight/Meter of Additional Travel	kg/m (lb/ft)	6.1 (4.1)	7.3 (4.9)	13.7 (9.2)	15.5 (10.4)	29.4 (19.8)	33.6 (22.6)	31.5 (21.2)
<b>Moment of Inertia (related to the drive shaft)</b>								
Standard Carriage, NL	kg-cm <sup>2</sup> (lb-in <sup>2</sup> )	17.8 (6.1)	18.4 (6.3)	142 (48)	146 (50)	725 (247)	743 (253)	698 (238)
Extended Carriage, VL	kg-cm <sup>2</sup> (lb-in <sup>2</sup> )	25.4 (8.7)	26.5 (9.0)	197 (67)	204 (70)	1121 (382)	1154 (393)	845 (288)
<b>Travel and Speed</b>								
Maximum Speed <sup>(2)</sup>	m/s (in/s)	5 (200)		5 (200)		5 (200)		5 (200)
Maximum Acceleration <sup>(2)</sup>	m/s <sup>2</sup> (in/s <sup>2</sup> )	10 (393)		10 (393)		10 (393)		10 (393)
Max. Travel, Standard Carriage NL <sup>(3)</sup>	mm (in)	5540 (218)	5520 (217)	9470 (372)	9440 (371)	9240 (363)	9200 (362)	8680 (341)
Max. Travel, Extended Carriage VL <sup>(3)</sup>	mm (in)	5390 (212)	5370 (211)	9270 (365)	9240 (363)	8940 (352)	8900 (350)	8380 (330)
<b>Geometric Data</b>								
Cross Section, Square	mm (in)	80 (3.15)		120 (4.72)		180 (7.09)		180 (7.09)
Moment of Inertia Ix	cm <sup>4</sup> (in <sup>4</sup> )	139 (3.34)		724 (17.39)		3610 (86.73)		3610 (86.73)
Moment of Inertia Iy	cm <sup>4</sup> (in <sup>4</sup> )	165 (3.96)		830 (19.94)		4077 (97.95)		4077 (97.95)
Moment of Elasticity	N/mm <sup>2</sup> (lb/in <sup>2</sup> )	0.72 x 10 <sup>5</sup> (0.1044 x 10 <sup>6</sup> )		0.72 x 10 <sup>5</sup> (0.1044 x 10 <sup>6</sup> )		0.72 x 10 <sup>5</sup> (0.1044 x 10 <sup>6</sup> )		0.72 x 10 <sup>5</sup> (0.1044 x 10 <sup>6</sup> )
<b>Pulley Data, Torques, Forces</b>								
Travel Distance per Revolution	mm/rev (in/rev)	180 (709)		270 (10.63)		420 (16.54)		280 (11.02)
Response Radius of Drive Pulley	mm (in)	28.7 (1.13)		43.0 (1.69)		66.8 (2.63)		44.6 (1.75)
Maximum Drive Torque	Nm (lb-in)	47.4 (420)		131.4 (1165)		368 (3264)		58 (514)
Maximum Belt Traction (effective load)		Refer to charts on following pages						
Repeatability <sup>(3)(4)</sup>	mm (in)	± 0.2 (± 0.008)		± 0.2 (± 0.008)		± 0.2 (± 0.008)		± 0.05 (± 0.002)

- (1) Includes weight of drive module.
- (2) Greater speeds and accelerations may be achieved.
- (3) Bumper to bumper maximum stroke - splicing possible for longer travel distances including safety zone.
- (4) Nominal value - component dependent. For improved repeatability consult factory.

**Linear Actuator Size Comparison**



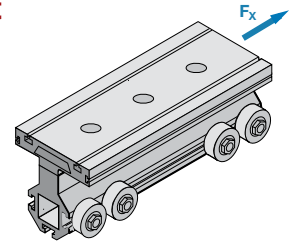


## HPLA080 Series – Load-Bearing Capacity of Carriage and Timing Belt

### Load-Bearing Capacity of HPLA080 Timing Belt ( $F_x$ )

Description	Gearhead	Drive Option	Transferable Thrust Force (n)	
			Nominal Belt Tension (81,000 km life)	Maximum Belt Tension (46,000 km life)
Unsupported Pulley	PX90/PV90	S01/S02	500	625
	PS90	S01/S02	675	900
Supported Pulley	PX90/PX115 PV90/PV115 PS90	S03/S04/ S08/S09	925	1115

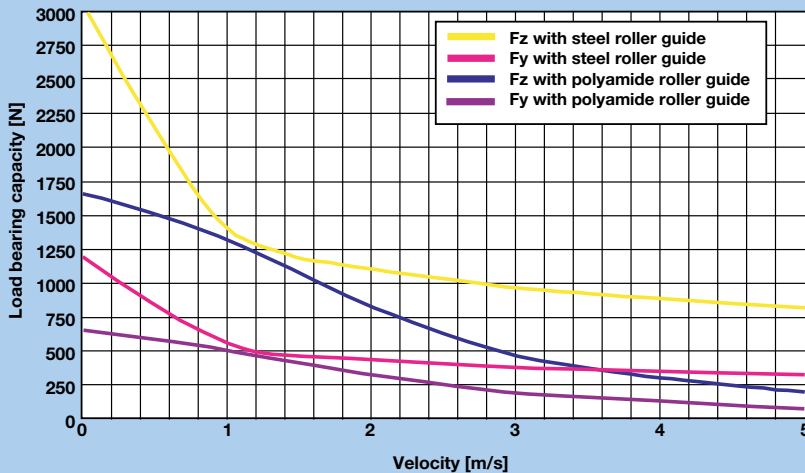
The forces and moments that the carriage is capable of transferring are speed-dependent. The



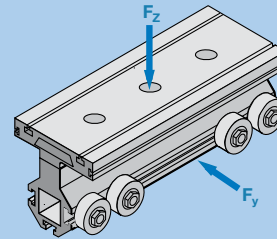
curves shown in the graphs apply to a standard carriage (S). With the extended carriage (E), all the values apart from  $F_x$  (load-bearing capacity of timing belt) can be doubled if the load is applied equally to both halves of the carriage or distributed uniformly along its entire length.

### HPLA080 Load-Bearing Capacity ( $F_y$ and $F_z$ )

(Values double for extended carriage)



The curves show the maximum load-bearing capacity of a carriage in one direction of force or torque. If several loads are applied in different directions, the values given by the curves must be derated, i.e. the load or speed should be reduced if necessary.

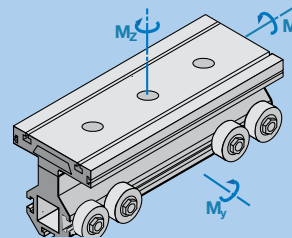
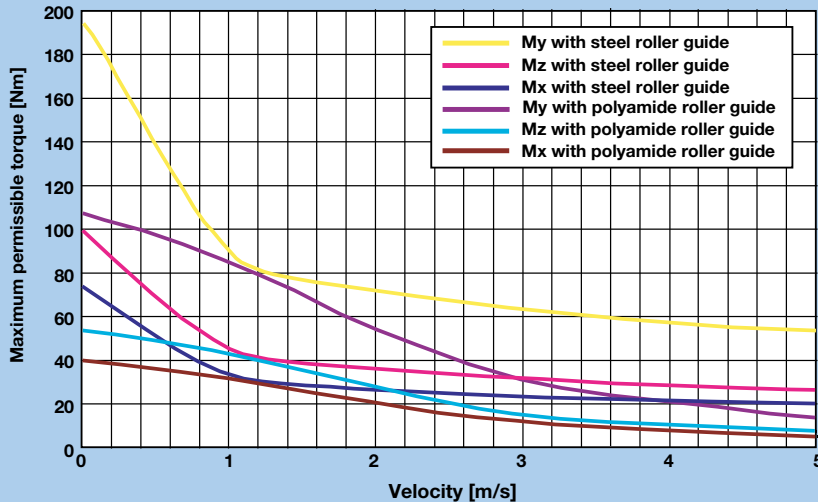


“DimAxes” software is available for determination of precise carriage loading.

Visit [www.parkermotion.com](http://www.parkermotion.com) to request a Gantry Robot CD.

### HPLA080 Maximum Permissible Moment Load ( $M_x$ , $M_y$ and $M_z$ )

(Values double for extended carriage)

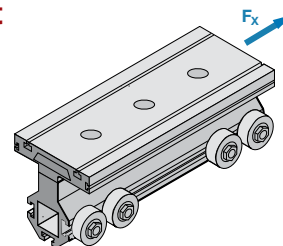


**HPLA120 Series – Load-Bearing Capacity of Carriage and Timing Belt**

**Load-Bearing Capacity of HPLA120 Timing Belt (Fx)**

Description	Gearhead	Drive Option	Transferable Thrust Force (n)	
			Nominal Belt Tension (81,000 km life)	Maximum Belt Tension (46,000 km life)
Unsupported Pulley	PV115/PX115	S01/S02	675	900
	PS115	S01/S02	1515	2015
Supported Pulley	PV115 PX115 PS90/PS115	S03/S04/ S08/ S09	1700	2235

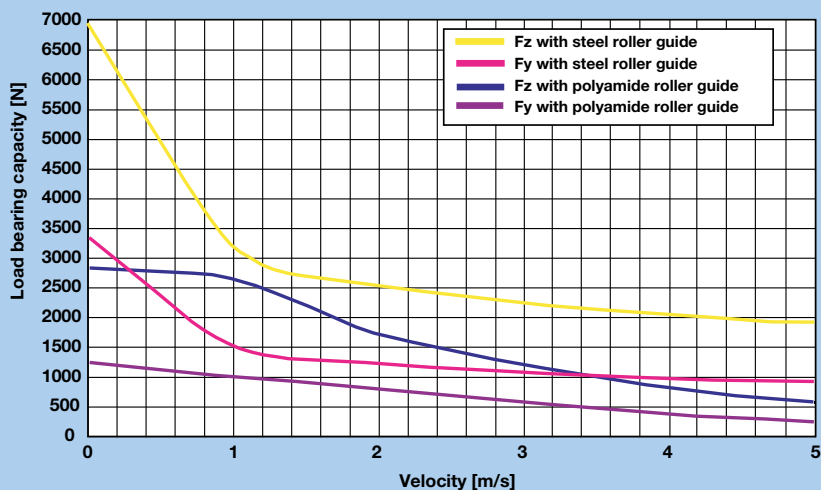
The forces and moments that the carriage is capable of transferring are speed-dependent. The



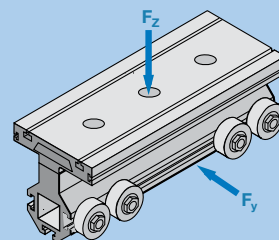
curves shown in the graphs apply to a standard carriage (S). With the extended carriage (E), all the values apart from Fx (load-bearing capacity of timing belt) can be doubled if the load is applied equally to both halves of the carriage or distributed uniformly along its entire length.

**HPLA120 Load-Bearing Capacity (Fy and Fz)**

(Values double for extended carriage)

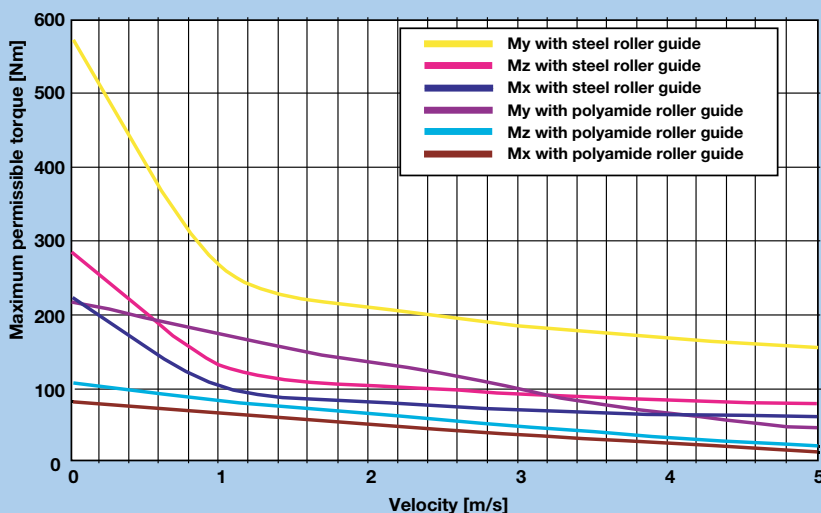


The curves show the maximum load-bearing capacity of a carriage in one direction of force or torque. If several loads are applied in different directions, the values given by the curves must be derated, i.e. the load or speed should be reduced if necessary.

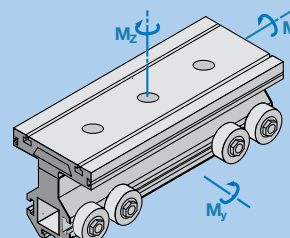


**HPLA120 Maximum Permissible Moment Load (Mx, My and Mz)**

(Values double for extended carriage)



**“DimAxes” software is available for determination of precise carriage loading.**  
Visit [www.parkermotion.com](http://www.parkermotion.com) to request a Gantry Robot CD.





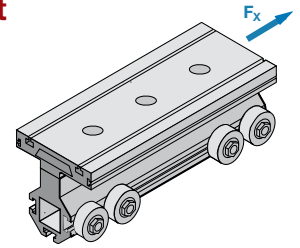


## HPLA180 Series – Load-Bearing Capacity of Carriage and Timing Belt

### Load-Bearing Capacity of HPLA180 Timing Belt ( $F_x$ )

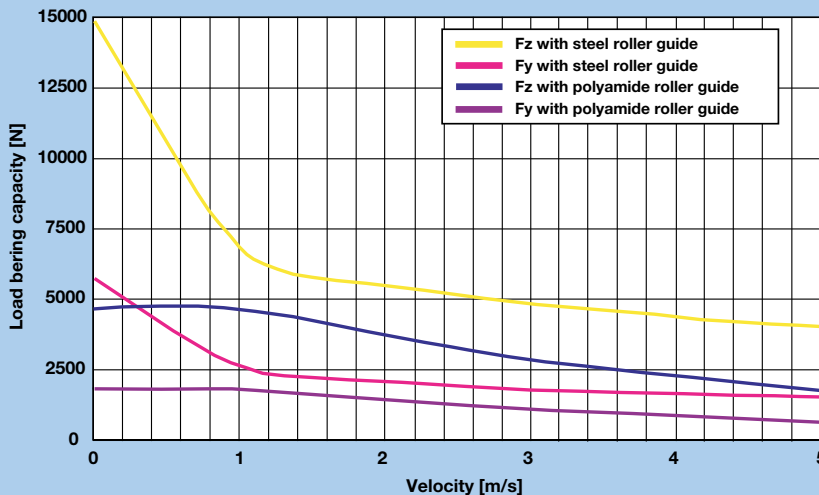
Description	Gearhead	Drive Option	Transferable Thrust Force (n)	
			Nominal Belt Tension (81,000 km life)	Maximum Belt Tension (46,000 km life)
Unsupported Pulley	PS142	S01/S02	1405	1804
Supported Pulley	PS115 PS142	S03/S04/ S08/S09	4170	5455

The forces and moments that the carriage is capable of transferring are speed-dependent. The curves shown in the graphs apply to a standard carriage (S). With the extended carriage (E), all the values apart from  $F_x$  (load-bearing capacity of timing belt) can be doubled if the load is applied equally to both halves of the carriage or distributed uniformly along its entire length.

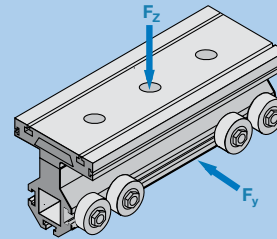


### HPLA180 Load-Bearing Capacity ( $F_y$ and $F_z$ )

(Values double for extended carriage)

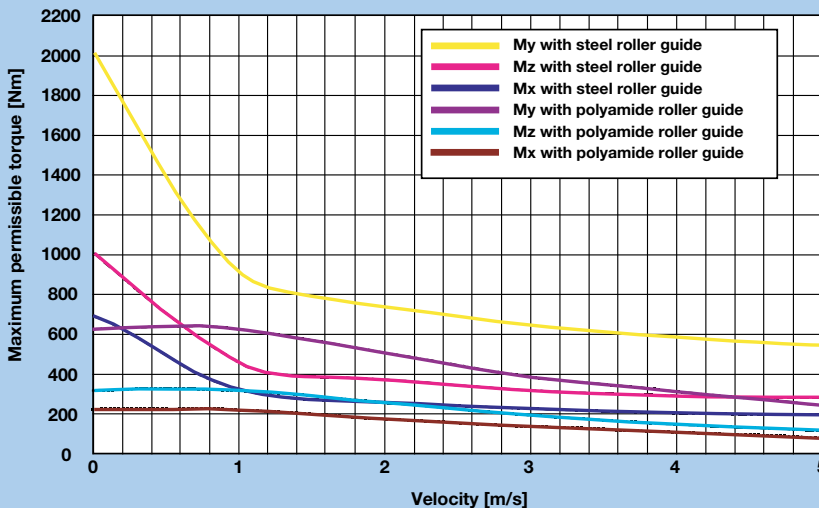


The curves show the maximum load-bearing capacity of a carriage in one direction of force or torque. If several loads are applied in different directions, the values given by the curves must be derated, i.e. the load or speed should be reduced if necessary.

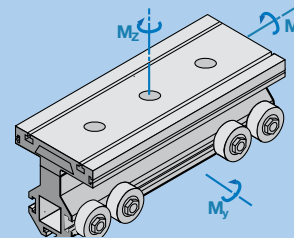


### HPLA180 Maximum Permissible Moment Load ( $M_x$ , $M_y$ and $M_z$ )

(Values double for extended carriage)



“DimAxes” software is available for determination of precise carriage loading. Visit [www.parkermotion.com](http://www.parkermotion.com) to request a Gantry Robot CD.

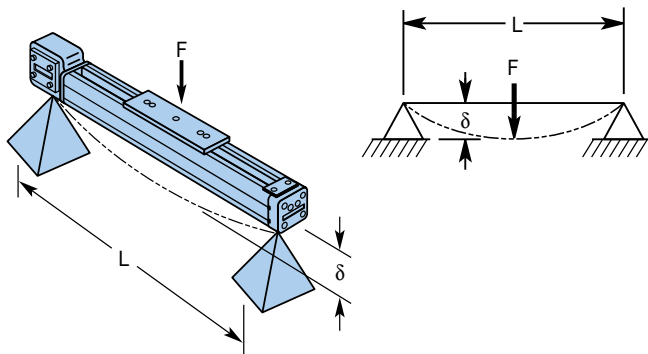


Belt Driven Tables

**HPLA Characteristics**

The HPLA deflection curves can be used for determining the deflection based on the profile length and the application load weight. Applications requiring high acceleration forces can place a severe strain on the system stability. In these cases, a solid substructure may be required with the HPLA product being supported at frequent intervals.

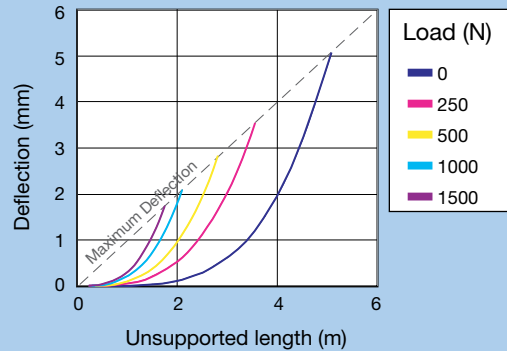
These deflection curves illustrate the deflection  $\delta$ , based on the HPLA profile being simply supported at both ends. The graphs take into consideration the self deflection due to the weight of the profile, along with the load to be transported. The maximum deflection cannot be exceeded. If the maximum deflection is exceeded based on your application parameters, then additional supports are required. Alternatively, the next larger profile size may be considered. For deflection formulas and calculations, please refer to the Technical Information Library found on our web site: [www.parkermotion.com](http://www.parkermotion.com)



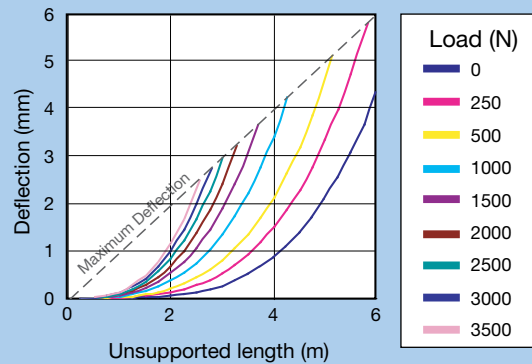
F = Force N  
L = Unsupported length mm  
 $\delta$  = Deflection mm

**Deflection Curves**

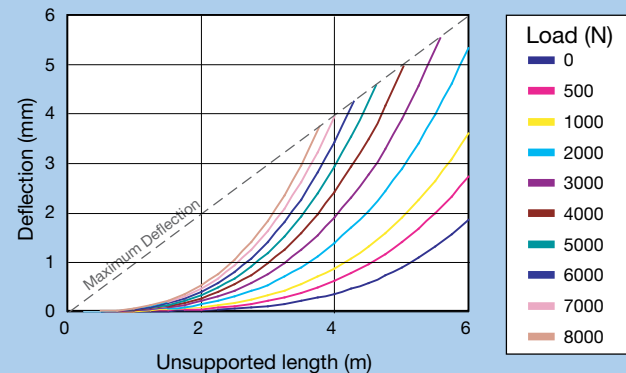
**HPLA080**



**HPLA120**



**HPLA180**

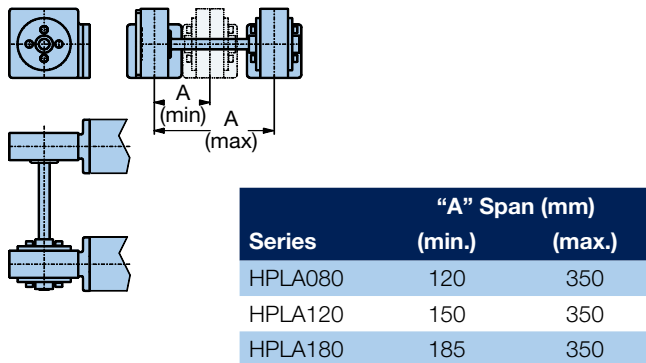




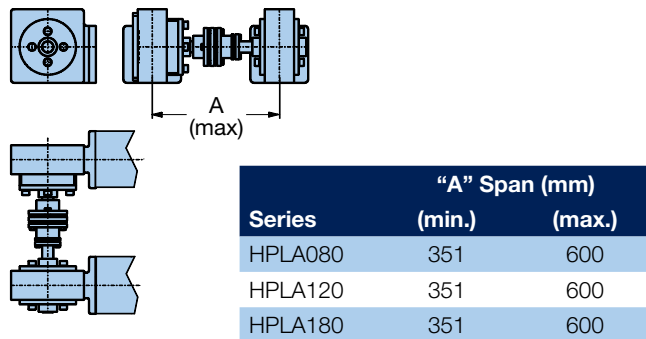
## Dual Axis Considerations

When two parallel linear modules are required to form a single axis, the span or distance between each unit determines which type of shaft connection is required. In some cases, a link shaft support bearing might also be required.

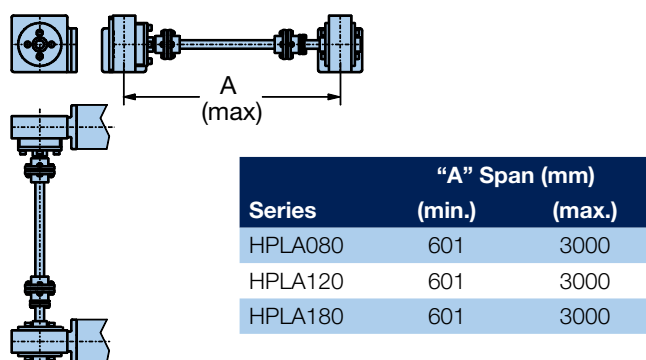
**Figure A**



**Figure B**

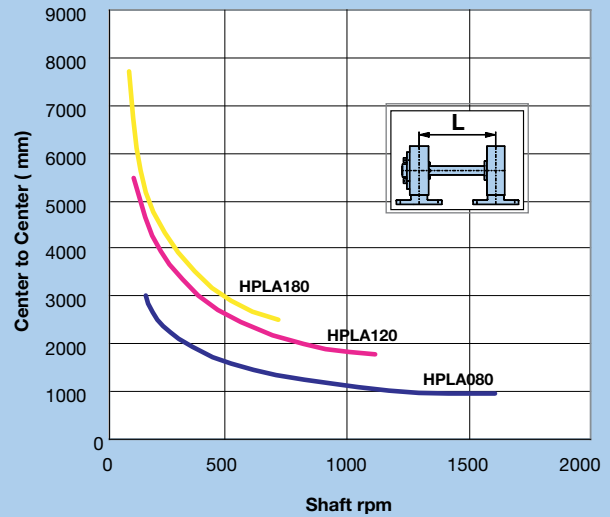


**Figure C**

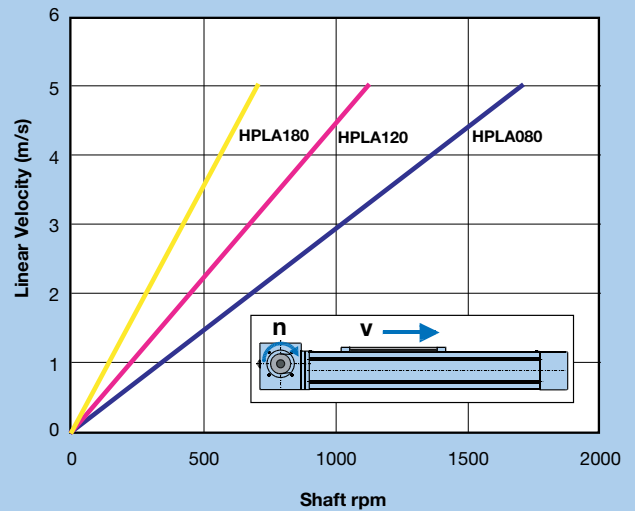


The link shaft bearing is used to support the linking shaft of an HPLA dual axis when there is a large center to center distance. This bearing must be used if the critical speed is exceeded with the dual-axis link shaft.

### Critical Speed



### Linear Velocity

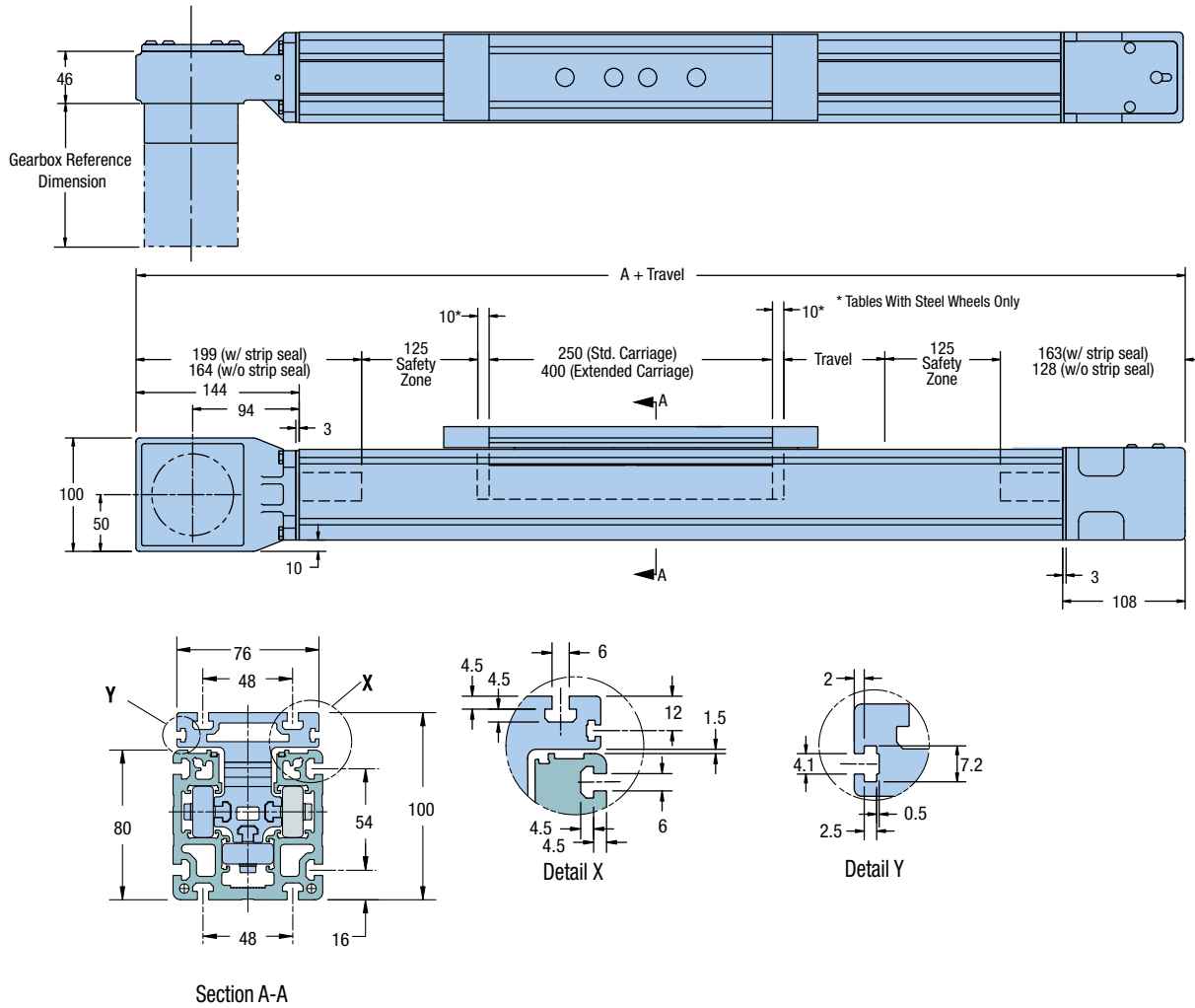


Belt Driven Tables



HPLA080 Drive Unit

Dimensions (mm)

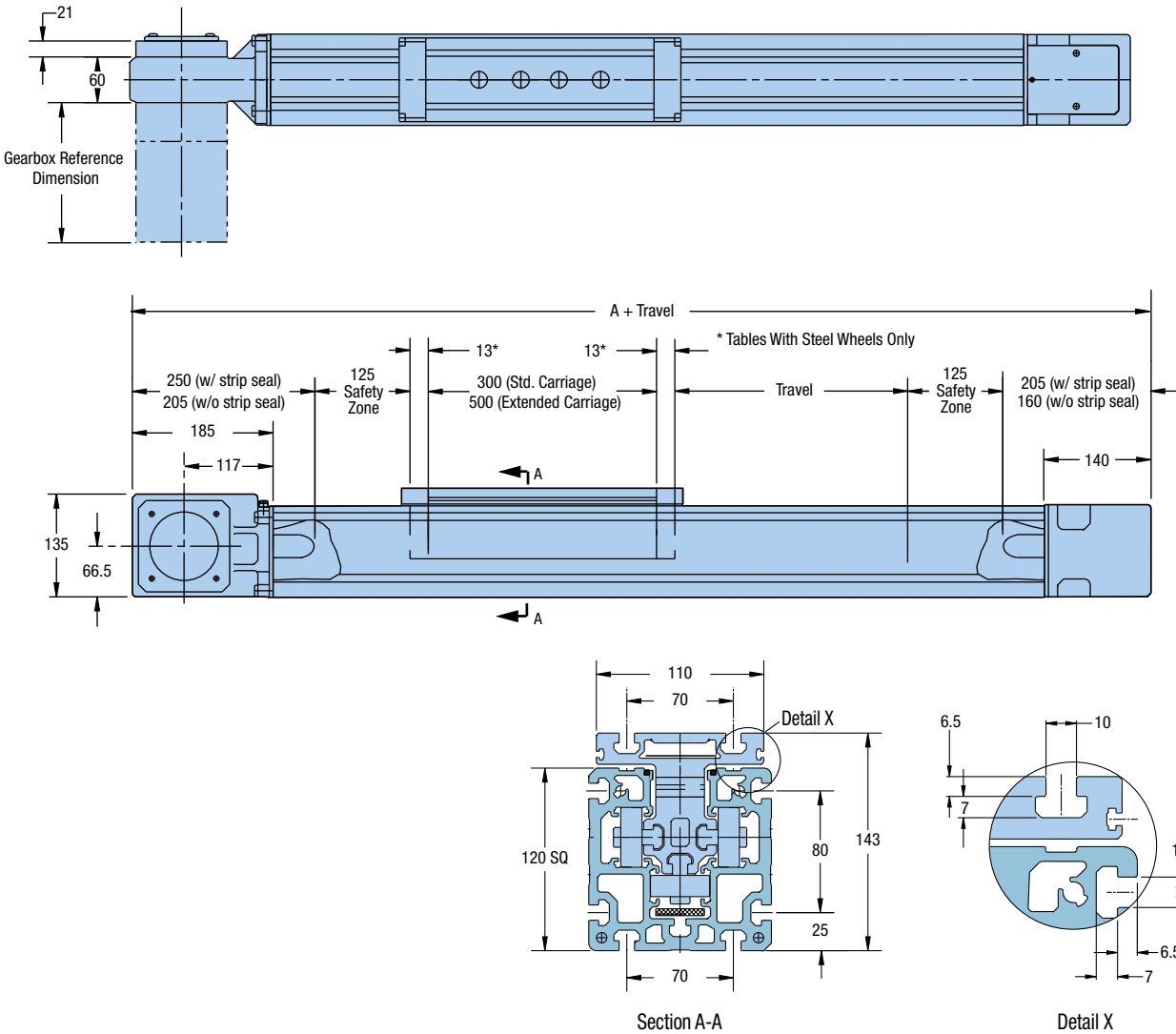


Description	Dimension A (mm)	
	With Strip Seal	Without Strip Seal
Standard Carriage - Polyamide Wheels	862	792
Standard Carriage - Steel Wheels	882	812
Extended Carriage - Polyamide Wheels	1012	942
Extended Carriage - Steel Wheels	1032	962



HPLA120 Drive Unit

Dimensions (mm)



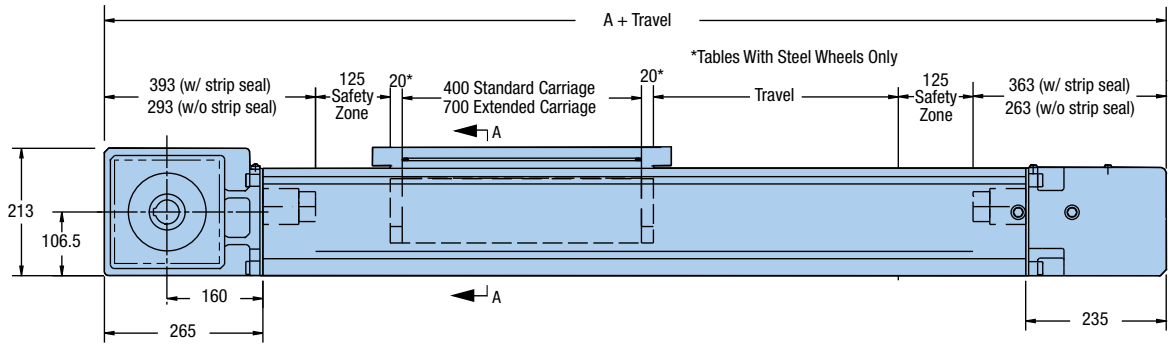
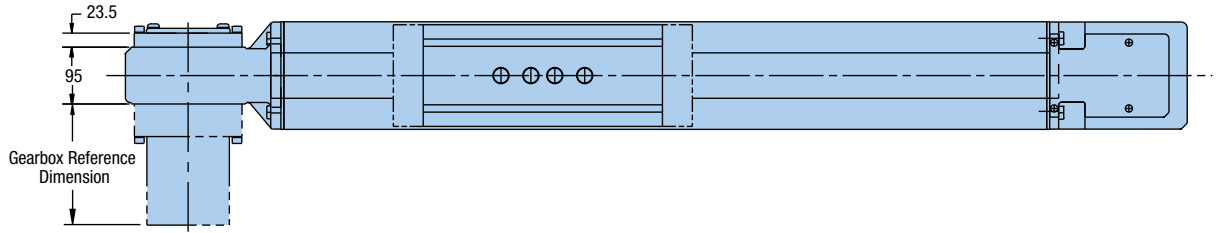
Belt Driven Tables

Description	Dimension A (mm)	
	With Strip Seal	Without Strip Seal
Standard Carriage - Polyamide Wheels	1005	915
Standard Carriage - Steel Wheels	1031	941
Extended Carriage - Polyamide Wheels	1205	1115
Extended Carriage - Steel Wheels	1231	1141



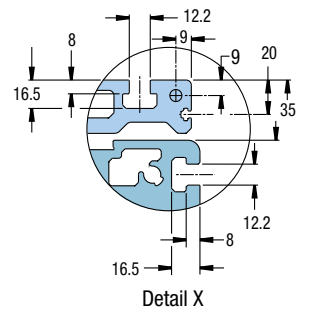
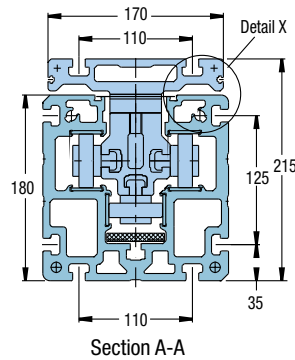
**HPLA180 Drive Unit**

Dimensions (mm)

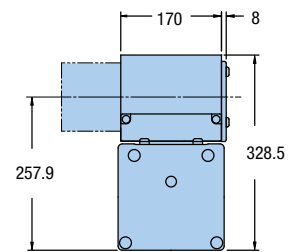
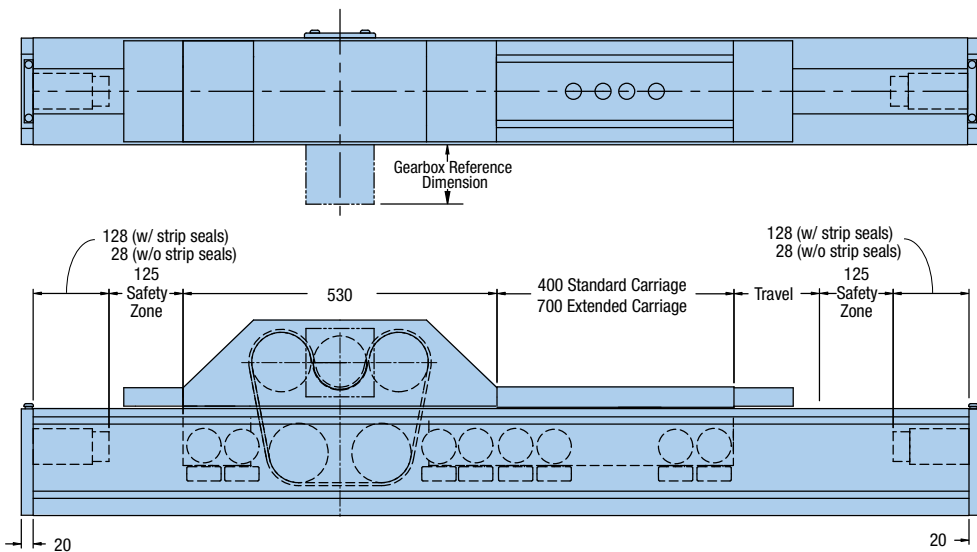


\*Tables With Steel Wheels Only

Description	Dimension A (mm)	
	With Strip Seal	Without Strip Seal
Standard Carriage - Polyamide Wheels	1408	1206
Standard Carriage - Steel Wheels	1446	1246
Extended Carriage - Polyamide Wheels	1706	1506
Extended Carriage - Steel Wheels	1746	1546



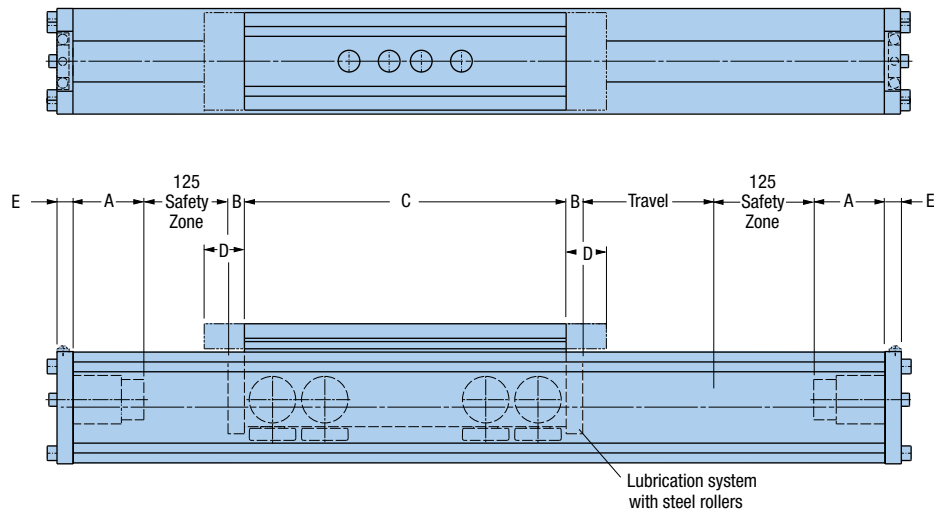
**HPLA180 Rack Drive Unit**





## Idler Unit Dimensions

Dimensions (mm)



Series	Carriage Length	Wheel Type	Dimensions (mm)									
			With Strip Seal					Without Strip Seal				
			A	B	C	D	E	A	B	C	D	E
HPLA080	Standard	Polyamide	55	-	250	40	10	20	-	250	-	10
HPLA080	Extended	Polyamide	55	-	400	40	10	20	-	400	-	10
HPLA080	Standard	Steel	55	10	250	40	10	20	10	250	-	10
HPLA080	Extended	Steel	55	10	400	40	10	20	10	400	-	10
HPLA120	Standard	Polyamide	65	-	300	50	15	20	-	300	-	15
HPLA120	Extended	Polyamide	65	-	500	50	15	20	-	500	-	15
HPLA120	Standard	Steel	65	13	300	50	15	20	13	300	-	15
HPLA120	Extended	Steel	65	13	500	50	15	20	13	500	-	15
HPLA180	Standard	Polyamide	128	-	400	100	20	28	-	400	-	20
HPLA180	Extended	Polyamide	128	-	700	100	20	28	-	700	-	20
HPLA180	Standard	Steel	128	20	400	100	20	28	20	400	-	20
HPLA180	Extended	Steel	128	20	700	100	20	28	20	700	-	20

Belt Driven Tables

Fill in an order code from each of the numbered fields to create a complete model order code.

① ② ③ ④ ⑤ ⑥ ⑦ ⑧ ⑨ ⑩ ⑪ ⑫ ⑬ ⑭

**Order Example:** HPLA080 D1 B1 T2000 C1 DA1000 S08 F02 G2-05 K24 R1 H1 LH1 E1

① **Series**

HPLA080  
HPLA120  
HPLA180

② **Drive System**

D0 Idler Unit  
D1 Timing Belt Drive, Nominal Thrust, Maximum Life  
D2 Timing Belt Drive, Maximum Thrust, Nominal Life  
D9 Internal Rack and Pinion (HPLA180 only)

③ **Bearing Option**

B1 Polyamide Rollers  
B2 Steel Rollers

④ **Travel**

Tnnnn Specified travel in mm (nnnn = mm)

⑤ **Carriage**

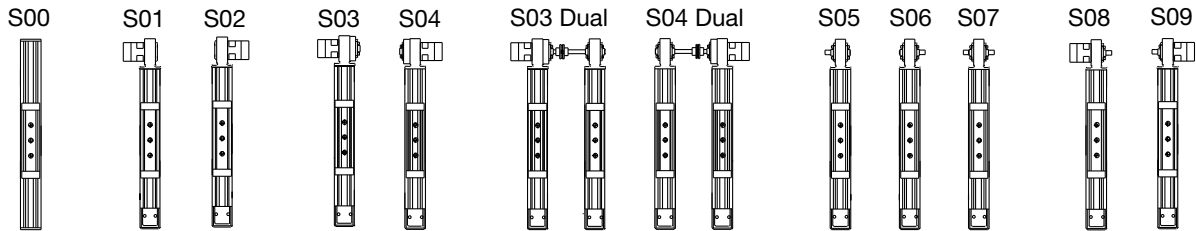
C1 Standard Length Carriage with Load Plate\*  
C2 Extended Length Carriage with Load Plate\*  
C3 Standard Length Carriage with Clamping Bar\*  
C4 Extended Length Carriage with Clamping Bar\*  
\* See photos below.

⑥ **Link Shaft Option**

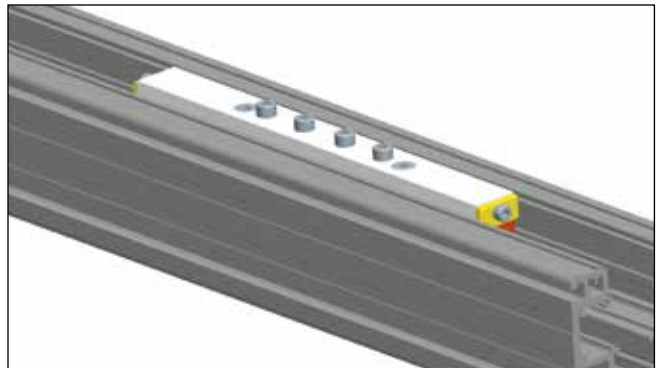
DA0000 No Link Shaft - Single Axis or Idler Unit  
DAnnnn Double Unit, Specify Center to Center Distance (mm)

⑦ **Drive Shaft Configuration**

S00 No Shaft, Idler Unit  
S01 Unsupported Pulley, Flange Left  
S02 Unsupported Pulley, Flange Right  
S03 Supported Pulley, Flange Left  
S04 Supported Pulley, Flange Right  
S05 Supported Pulley, Shaft Option, Left  
S06 Supported Pulley, Shaft Option, Right  
S07 Supported Pulley, Shaft Option, Both  
S08 Supported Pulley, Flange Left, Shaft Right  
S09 Supported Pulley, Flange Right, Shaft Left



Load Plate carriage option



Clamping Bar carriage option





## ⑧ Drive Housing Flange

<b>F00</b>	No Flange
<b>F08</b>	PV90/PX90 Flange (HPLA80 ONLY)
<b>F09</b>	PX115/PV115 Flange (HPLA080 and HPLA120 only)
<b>F10</b>	PS90 Flange (HPLA080 and HPLA120 only)
<b>F11</b>	PS115 Flange (HPLA120 & HPLA180 only)
<b>F12</b>	PS142 Flange (HPLA180 only)

## ⑨ Gearbox Option

<b>G0-00</b>	No Gearbox
<b>G08-nn</b>	PX90 Gearbox included
<b>G09-nn</b>	PX115 Gearbox included
<b>G10-nn</b>	PS90 Gearbox included
<b>G11-nn</b>	PS115 Gearbox included
<b>G12-nn</b>	PS142 Gearbox included
<b>G14-nn</b>	PV90 Gearbox included
<b>G15-nn</b>	PV115 Gearbox included

nn = ratio

Single stage ratios 3:1, 5:1, 10:1    Dual stage ratios 15:1, 25:1

## ⑩ Motor Kit Option

<b>K00</b>	No Flange
<b>K20</b>	NEMA23 stepper, 1/4" shaft
<b>K21</b>	BE23
<b>K23</b>	SMN60, MPM72 (metric), N070, J070
<b>K24</b>	SMN82, MPM89 (metric), N092, J092
<b>K26</b>	BE34
<b>K34</b>	MPP092x motor kit
<b>K36</b>	Parker MPP100/MPJ100
<b>K39</b>	Parker MPP115/MPJ115
<b>K41</b>	Parker MPP142/MPJ142
<b>K50</b>	Parker HDY55; MPL15XX (Allen Bradley)
<b>K51</b>	AKM3X-AN (Kollmorgen)
<b>K52</b>	SGMAH-04 (Yaskawa)
<b>K53</b>	SGMAH-08 (Yaskawa)
<b>K54</b>	MKD041 (Indramat)
<b>K55</b>	AKM4X-AN (Kollmorgen)
<b>K56</b>	MKD070 (Indramat)
<b>K57</b>	MKD090 (Indramat)

## ⑪ Environmental Option

<b>R1</b>	Standard preparation with strip seal <sup>1</sup>
<b>R2</b>	Standard preparation with no strip seal
<b>R3</b>	Corrosion resistant preparation with strip seal <sup>1, 2</sup>
<b>R4</b>	Corrosion resistant preparation with no strip seal <sup>2</sup>

<sup>1</sup> C1, C2 Carriage Load Plate Only

<sup>2</sup> B1 Bearing Option Polyamide Rollers Only

## ⑫ Mounting Orientation

<b>H1</b>	Carriage Up
<b>H2</b>	Carriage Down
<b>H3</b>	Carriage on Side, Drive Station Up
<b>H4</b>	Carriage on Side, Drive Station Down

## ⑬ Limit/Home Switch Option\*

<b>LH0</b>	No Limit Switch Assembly
<b>LH1</b>	Three Mechanical Switches
<b>LH2</b>	Two Mechanical Switches, One Proximity (NPN)
<b>LH3</b>	Three NPN Prox Switches, 10-30 VDC
<b>LH4</b>	Three PNP Prox Switches, 10-30 VDC

\*C1, C2 Carriage Load Plate Only

## ⑭ Linear Encoder

<b>E1</b>	Without Linear Encoder
<b>E5</b>	5.0 Micron Resolution, Magnetic Type
<b>E7</b>	Sine Cosine Output, Magnetic Type

\*C1, C2 Carriage Load Plate Only