

# 3 Strain Relief Systems

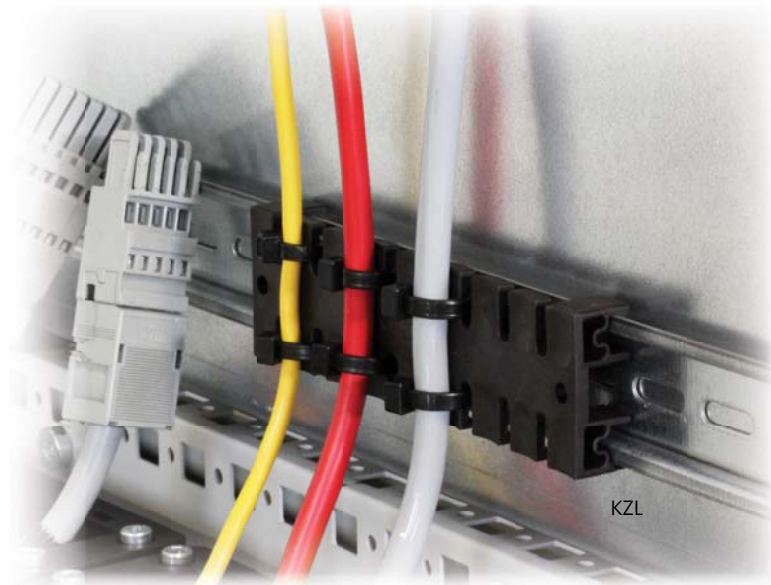

## At a Glance ...

By using icotek strain relief systems the user can quickly assemble, organize and provide strain relief for cables according to EN 50262.

The systems can be used for organizing and securing cables in machines, panels, electronic enclosures and dynamic cable carriers.

## Benefits ...

### 1. Universal Use

Due to many types of DIN rails and screw type assembly methods, icotek offers numerous mounting options.

### 2. Fast and Easy Assembly

Securing the cables is done quickly and inexpensively with standard cable ties (see Page 145).

### 3. Secure Hold

The shape of the strain relief securely holds cable tie and cable.

### 4. High Packing Density

The strain relief plates are available in several sizes. The packing density can be greatly increased by multilayer mounting.

### 5. Flexibility

Due to the wide variety of sizes and designs, a matching product for each application can be found.

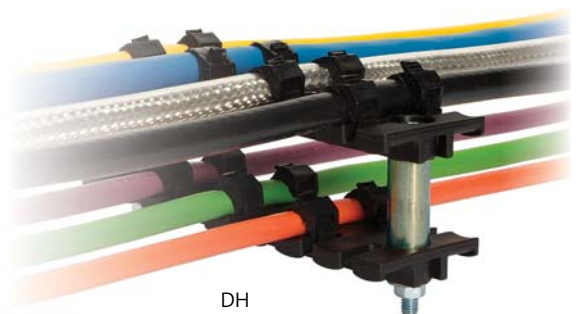

## Product Group 3

Strain Relief Systems

### Chapter Content

<b>Strain Relief Plates for Mounting Rails</b> KZL	Page	70
<b>Strain Relief Plates for DIN Rails Shape H</b> SF ZL	Page	71
<b>Strain Relief Plates for Screw Assembly</b> ZL	Page	72
<b>Strain Relief Plates with Bushings</b> ZL-AB	Page	73
<b>Strain Relief Plates for Screw Assembly</b> ZL 03   04   05	Page	74
<b>Distance Bushings</b> DH	Page	75

3

# KZL

## Strain Relief Plates for Mounting Rails

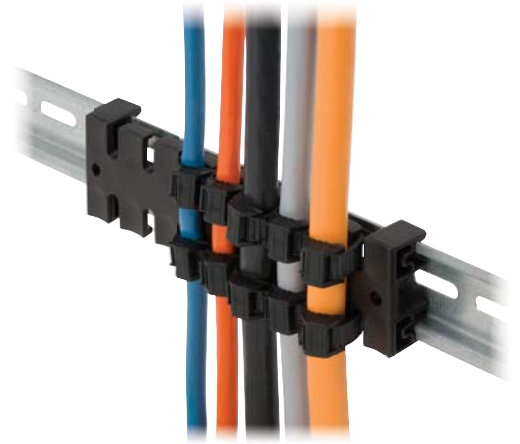

### Product Description

The strain relief plate KZL is used for static or dynamic applications for organizing and securing cables on machines, control panels or cable carriers.

The undercut on the comb shaped profile provides secure strain relief according to EN 50262. Fixation of the cables is achieved by using cable ties.

KZL Strain relief plates are available for 30 mm DIN rails shape C or 35 mm DIN rails shape H.

### Advantages

- Simple assembly
- Cost-effective
- High packing density
- Universal usage

### Specifications

Material **Polyamide (PA)**  
 Flame class **UL94-Vo, self-extinguishing**  
 Temperature **- 40°C to + 140°C (static)**  
 Properties **Halogen free, silicone free**

### Accessories

KB Cable ties Page 145

Type	Order No. for H-rails	Order No. for C-rails	Length L1	Length L2	No. of teeth	PU
------	--------------------------	--------------------------	--------------	--------------	-----------------	----

KZL 39	32260	32261	38.5 mm	28.3 mm	3	10
KZL 80	32262	32263	79.5 mm	68 mm	6	10
KZL 140	32264	32265	139.5 mm	128.1 mm	9	10

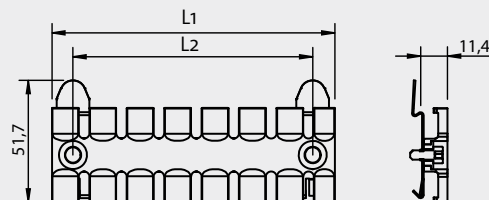
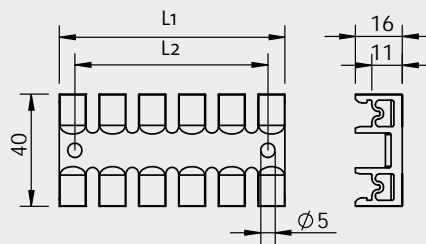

# SF|ZL

## Strain Relief Plates for 35 mm DIN Rail



Type	Order No.	Length L1	Length L2	No. of teeth	PU
SF ZL 39	32351	38.5 mm	19.5 mm	3	10
SF ZL 60	32352	59.5 mm	43.5 mm	4	10
SF ZL 70	32353	69.1 mm	43.5 mm	5	10
SF ZL 87	32354	86.5 mm	68 mm	6	10
SF ZL 103	32355	102.5 mm	84 mm	7	10
SF ZL 121	32356	121 mm	102.5 mm	8	10
SF ZL 140	32357	139.5 mm	121 mm	9	10
SF ZL 180	32358	180 mm	157 mm	12	10

### Product Description

The strain relief plate SF|ZL is used for assembly on 35 mm DIN rails shape H. It can be used for strain relief of cables and conduits.

The SF|ZL range is based upon the strain relief plate ZL, which is mounted on snap feet for 35 mm DIN rails shape H.

### Advantages

- Simple assembly
- Cost-effective
- High packing density
- Universal usage

### Specifications

Material	ZL: Polyamide (PA) SF-foot: Spring steel
Flame class	UL94-Vo, self-extinguishing
Temperature	- 40°C to + 140°C (static)
Properties	Halogen free, silicone free

### Accessories

KB Cable ties Page 145

## ZL

### Strain Relief Plates for Screw Assembly



### Product Description

The strain relief plate ZL is used for static or dynamic applications for organizing and securing cables on machines, control panels or cable carriers.

The undercut on the comb shaped profile provides secure strain relief according to EN 50262. Fixation of the cables is achieved by using cable ties.

For multilayer installation please use distance bushings, see Page 75.

### Advantages

- Simple assembly
- Cost-effective
- High packing density
- Universal usage

### Specifications

Material **Polyamide (PA)**  
 Flame class **UL94-Vo, self-extinguishing**  
 Temperature **- 40°C to + 140°C (static)**  
 Properties **Halogen free, silicone free**

### Accessories

DH Distance bushings Page 75  
 KB Cable ties Page 145

Type	Order No.	Length L1	Length L2	No. of teeth	PU
ZL 39	32222	38.5 mm	19.5 mm	3	10
ZL 60	32224	59.5 mm	43.5 mm	4	10
ZL 70	32226	69.1 mm	43.5 mm	5	10
ZL 87	32228	86.5 mm	68 mm	6	10
ZL 103	32230	102.5 mm	84 mm	7	10
ZL 121	32232	121 mm	102.5 mm	8	10
ZL 140	32234	139.5 mm	121 mm	9	10
ZL 180	32236	180 mm	157 mm	12	10

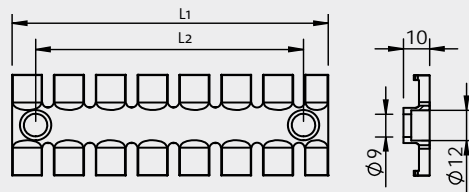

# ZL-AB

## Strain Relief Plates for Screw Assembly



Inlay bushings also available in brass.

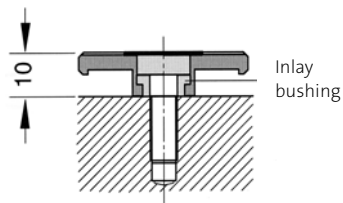

Type	Order No.	Order No.	Order No.	Length L1	Length L2	No. of teeth	PU
	for M4 screws	for M5 screws	for M6 screws				
ZL 39 AB	32270	32280 32360	32290	38.5 mm	19.5 mm	3	10
ZL 60 AB	32271	32281 32361	32291	59.5 mm	43.5 mm	4	10
ZL 70 AB	32272	32282 32362	32292	69.1 mm	43.5 mm	5	10
ZL 87 AB	32273	32283 32363	32293	86.5 mm	68 mm	6	10
ZL 103 AB	32275	32284 32364	32294	102.5 mm	84 mm	7	10
ZL 121 AB	32277	32285 32365	32295	121 mm	102.5 mm	8	10
ZL 140 AB	32274	32286 32366	32296	139.5 mm	121 mm	9	10
ZL 180 AB	32276	32287 32367	32297	180 mm	157 mm	12	10

### Product Description

The strain relief plate ZL-AB is used for static or dynamic applications for organizing and securing cables on machines, control panels or cable carriers.

By using aluminum / brass nuts for the screw holes, a better fit of the strain relief plate is achieved, even in high vibration environments.

### Advantages

- Simple assembly
- Cost-effective
- High packing density
- Universal usage

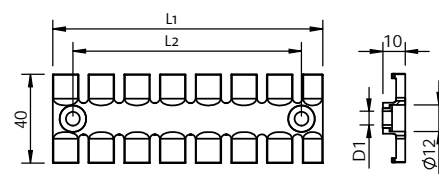

### Specifications

Material	ZL: Polyamide (PA)
Bushing:	
	Aluminum
	Brass (BR)
Flame class	UL94-Vo, self-extinguishing
Temperature	- 40°C to + 140°C (static)
Properties	Halogen free, silicone free

### Accessories

DH Distance bushings	Page 75
KB Cable ties	Page 145

# ZL 03 | 04 | 05

## Strain Relief Plates for Screw Assembly



### Product Description

Strain relief plates ZL feature different comb widths. Thus providing a multi-purpose product for various cable sizes.

The undercut on the comb shaped profile provides secure strain relief according to EN 50262. Fixation of the cables is achieved by using cable ties.

3

### Advantages

- Simple assembly
- Cost-effective
- High packing density
- Universal usage

### Specifications

Material **Polyamide (PA)**  
 Flame class **UL94-Vo, self-extinguishing**  
 Temperature **- 40°C to + 140°C (static)**  
 Properties **Halogen free, silicone free**

### Accessories

DH Distance bushings **Page 75**  
 KB Cable ties **Page 145**

Type	Order No.	Length L1	Length L2	No. of teeth	PU
ZL 03	32112	63 mm	50 mm	4 7	10
ZL 04	32114	95 mm	74.5 mm	6 11	10
ZL 05	32116	119 mm	108 mm	7 13	10

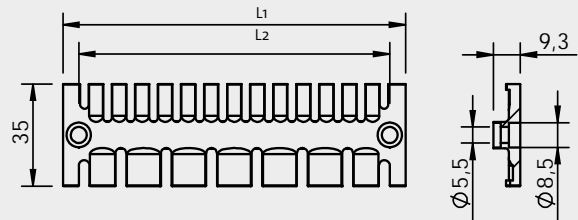

# DH Distance Bushings

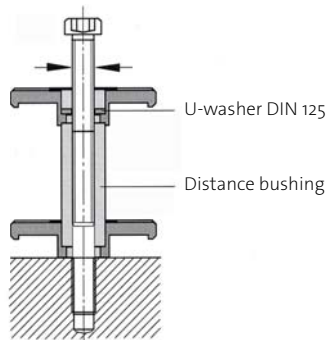

Type	Order No.	Fits with	Length	Diameter		PU
				inner	outer	
DH 30	32251	ZL 03   04   05	30 mm	5.2 mm	7 mm	10
DH 32	32252	ZL	32 mm	6.2 mm	12 mm	10

## Product Description

Due to DH distance bushings strain relief plates can be mounted in multi-layers to achieve an increase of the packing density.

## Advantages

- Increase of packing density

## Specifications

Material **Aluminum**

## Fits with

ZL Strain relief plates [Page 72](#)  
ZL-AB Strain relief plates [Page 73](#)