

PH PH-100/-500

High-precision, non-contact Magneswitch

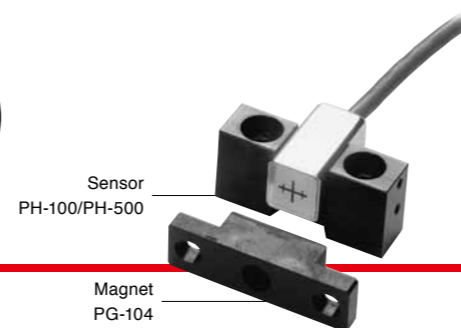

Outer dimensions

PG-104

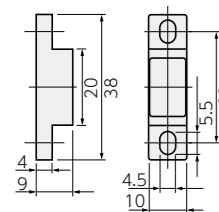

PH-100/500

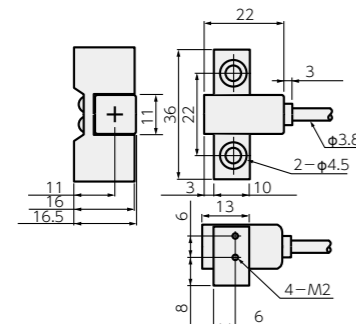

Unit: mm

- A combination of sensor PH-100/PH-500 and magnet PG-104 that are connected to our counter unit or detector can be used as a reference point for Magnescale or rotary encoder.
- Withstands extreme work conditions
- High precision: $\pm 1 \mu\text{m}$

Specifications

Model	PH-100	PH-500
Repeatability	$\pm 1 \mu\text{m}$ (under same conditions)	
Magnet	PG-104	
Clearance	Max. 3 mm	
Operating range	-10 °C to 50 °C	
Detection direction	Unidirectional	Both directions
Cable length	3 m	20 m

Magnescale

SPEED X PRECISION

Magnesensor
Magneswitch

Accessory

Wiper PZ3 (for SET-P15/-P16)

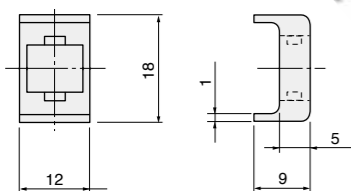

Unit: mm

Magnet mounting block PG-1 (for magnet PG-10/PG-104)

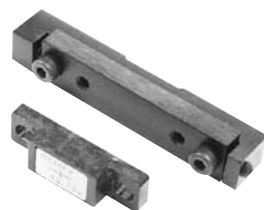

- Magnet (PG-104, PG-10) can be finely adjusted by $\pm 1 \text{ mm}$ in X direction.
- Very useful in setting a reference point

Wiper PH-1 (for magnesensor PH-11, PH-100, or PH-500)

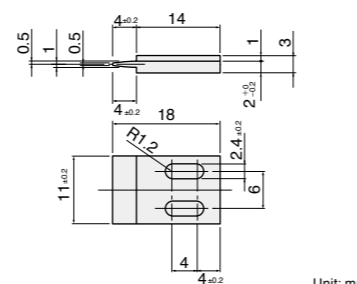
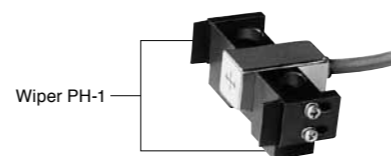

Unit: mm

Magnet PG-9010 (for SET-P15/-P16) singly

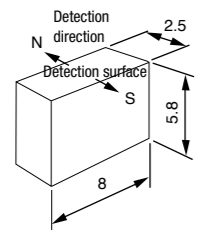

Unit: mm

Magnet PG-9104 singly PG-9104

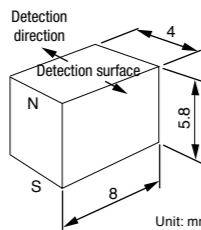

Unit: mm

- The operating range can be changed using magnet (PG-9104). This relationship is approximately as follow:
Operating range = $8 + 4(N - 1)$
 $\pm 1 \text{ mm}$ ($N = 1, 2, 3 \dots$)

CE15 Series extension cable for PK16

(Mini-DIN 6-pin plug ↔ mini-DIN 6-pin socket)

Model	Cable length
CE-15-3	3 m
-5	5 m
-10	10 m
-15	15 m
Compatible model	MJ100/110



Magnescale Co., Ltd.

Shinagawa Intercity Front 6F, 2-14-14, Konan, Minato-ku, Tokyo 108-0075, Japan

Headquarters : 45 Suzukawa, Isehara-shi, Kanagawa 259-1146, Japan TEL.+81 (0)463 92 1011 FAX.+81 (0)463 92 1012
 International Sales Department : 45 Suzukawa, Isehara-shi, Kanagawa 259-1146, Japan TEL.+81 (0)463 92 7971 FAX.+81 (0)463 92 7978 E-mail : info-mgs-eng@magnescale.com
 Magnescale Americas Inc. : 5740 Warland Drive, Cypress, CA 90630, USA TEL.+1 (562)594 5060 FAX.+1 (562)594 5061 E-mail : info-am@magnescale.com
 Magnescale Europe GmbH : Antoniusstrasse 14, 73249 Wernau, Germany TEL.+49(0)7153 934 291 FAX.+49(0)7153 934 299 E-mail : info-eu@magnescale.com
 Customer Support & Service Department : 45 Suzukawa, Isehara-shi, Kanagawa 259-1146, Japan TEL.+81 (0)463 92 2132 FAX.+81 (0)463 92 3090 E-mail : info-css@magnescale.com

<http://www.magnescale.com>

The contents of this literature are as of Jun. 2014

This catalog is printed with soy ink.

MGS-MS-1406-EN-C

For more information, please visit our website.

Magnescale Co., Ltd.

SET SET-B3/SET-K2

High-precision non-contact Magnesensor and Magneswitch

Outer dimensions

Magnet PG-104(PG-10)

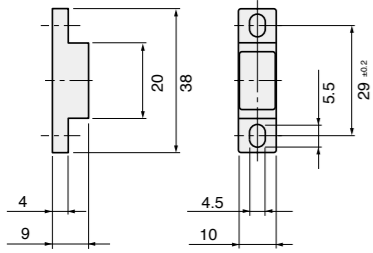

Sensor PH-11/PH-100

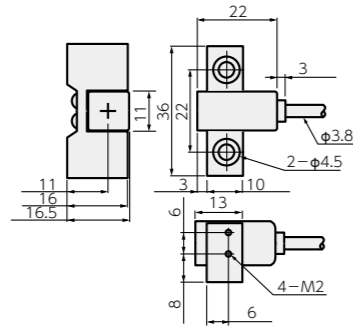

Detector PD-10

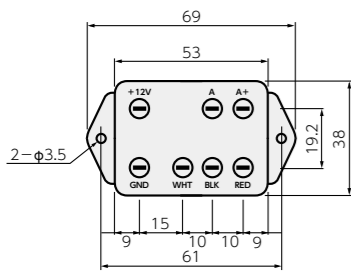

Detector PD-100

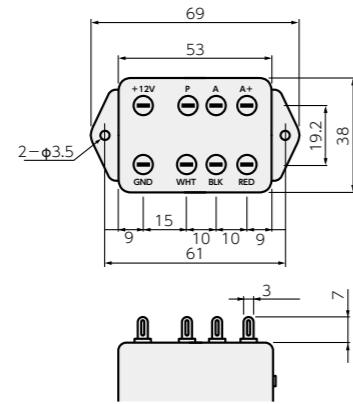

Unit: mm

Specifications

Model	SET-B3	SET-K2
Repeatability	±1 μm (under same conditions)*1	
Operating range	—	8 ±1 mm (at 0.5 mm/0.019" clearance)**
Clearance	Max. 2.5 mm	Max. 3 mm
Max. response frequency	1.7 kHz*2	—
Max. delay	—	0.1 ms*2
Power supply	12V DC ±5 %	12V DC ±10 %
Current consumption	Max. 40 mA	Max. 20 mA
Output impedance	3 kΩ	12 kΩ
Temperature characteristics	0.3 μm/°C (zero drift)	0.8 μm/°C*5
Voltage characteristics	0.2 μm or less/% (zero drift)	8 μm/V
Protective design grade	IP65 or equivalent for scale section, IP30 or equivalent for interface unit	
Operating temperature	-10 °C to 50 °C	
Cable length (sensor)	3 m/9.8' (expandable up to 15 m/49.2' by MSK-5000)*3	3 m/9.8' (expandable up to 30 m/98' by MSK-5000)*3
Cable length (interpolator)	Max. 100 m/328.0' by MSK-5100	Max. 20 m/65.6' by MSK-5100

Notes for items with *
(Magnesensor SET-B3)

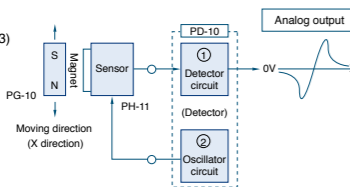

- *1 Repeatability: Conditions for ±1 μm: temperature change within ±1.2°C, voltage change within ±0.12 V, clearance change 3 μm or less, and speed change 10 mm/s or less.
- *2 Response speed: Response frequency characteristics 1.7 kHz. This is the input signal frequency where the relative output level drops by 3 dB in the response frequency characteristics. This causes the maximum response speed to be approx. 9 m/s if the standard magnet PG10 (PG-9010) is used.
- *3 Cable extension: Output voltage decreases approx. 2.3%/m by cable extension.

(Magneswitch SET-K2)

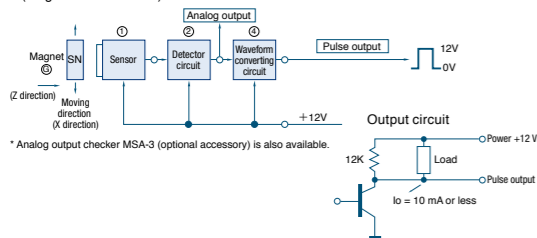

- *1 Repeatability: This indicates the accuracy of the position at which the pulse output goes ON (at 0.5 mm clearance).
- *2 Response speed: This is a proper time constant of the detector circuit and indicates a max. delay (T) from detection to pulse output rise. The maximum response speed is L/T where L is a practically allowable detection tolerance. When the detector's proper time constant is taken into account in use, the time delay is negligible (e.g., the detector head and magnet are operated at the same speed). The detector element's maximum response speed is 10 MHz.
- *3 When extending the cable, check the noise caused by external equipment.
- *4 Clearance: Clearance affects the operating range and repeatability.
- *5 Pay attention to the temperature characteristics.

Accuracy	1 μm	5 μm	10 μm
Max. response speed	10 mm/s	50 mm/s	100 mm/s

For position detection at the same speed, maximum speed change is caused.

SET SET-P15/-P16

High-precision, non-contact Magneswitch

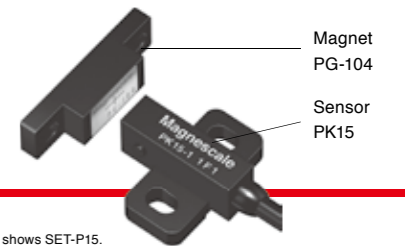

Outer dimensions

SET-P15 Magnet PG-104(PG-10)

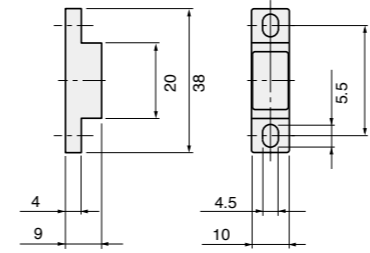

SET-P16 Magnet PG-104

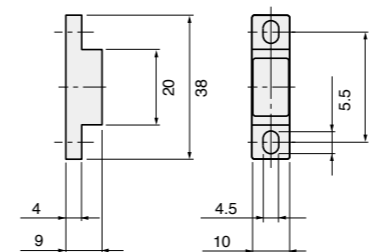

Sensor PK15

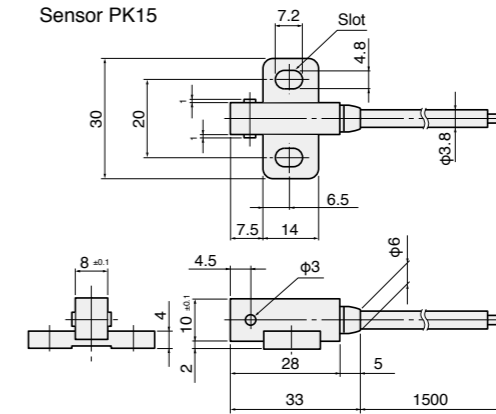

Sensor PK16

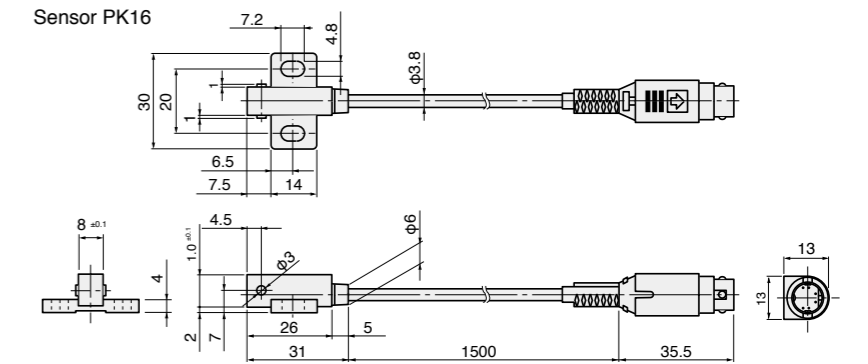

Unit: mm

- SET-P15 can be used as a reference point for DIGIRULER or as a limit switch.
- SET-P16 can be used as a reference point for DIGIRULER (interpolator MJ100/110 used in combination).
- Resistant to oil, dust, vibration, and impact and withstands extreme work conditions
- Repeatability: ±3 μm
- Max. response frequency: 10 kHz
- Built-in circuit for direct connection to a control unit (SET-P15)
- Indication lamp (LED) for visual confirmation that the switching action is being made

Specifications

Model	PK15			PK16
	-1	-2	-3	-1
Repeatability	±3 μm (under same conditions)*1			
Operating range	7.5 ±2 mm (at 1 mm clearance)			
Clearance	Max. 3 mm			
Max. response frequency	10 kHz			
Output	Circuit: NPN transistor, open collector			
	Operation: Turns ON in proximity			
	Contact capacity: Max. current 30 mA, max. voltage 30 V			
	Residual voltage: Residual voltage V _{OL} = 0.4 V or less at Isink of 30 mA			
Protection circuit: Surge killer, protection against reverse polarity				
Indication lamp	Red LED turns ON when activated			
Power supply	5V DC ±10 %	12V DC ±10 %	24V DC ±10 %	5V DC ±10 %
Current consumption	Max. 10 mA			
Protective design grade	IP67 or equivalent			
Insulation resistance	10 MΩ DC250 V*2			
Vibration resistance	49 m/s ² , 0 to 500 Hz			
Shock resistance	980 m/s ²			
Operating temperature	-10 °C to 60 °C			
Storage temperature	-20 °C to 80 °C			
Cable length	1.5 m/4.9' (expandable up to 30 m/98.4')			

- *1 Repeatability: This is unidirectional repeatability accuracy and indicates the accuracy of the position at which the reference point (stop) pulse output goes ON. Conditions for accuracy ±3 μm: temperature change within ±1.2°C, voltage change within ±1% 5 min. after the power supply is turned ON, clearance variation 1 mm
- *2 Provided between molded plastic housing and circuit, and shielded wire and circuit

