

17HA SERIES 0.9°

Key Features

- High Accuracy
- Low Noise
- Smooth Movement

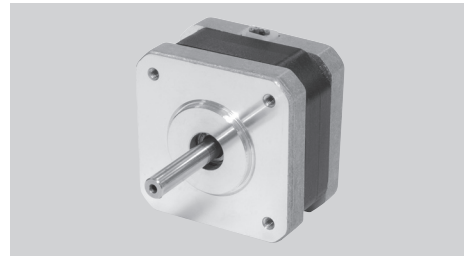

General Specifications

- Bi-polar

Series & Length	Model Number	Holding Torque		Rated Current	Resistance per Phase	Inductance per Phase	Detent Torque		Rotor Inertia	
		mNm	oz-in	A	ohm	mH	mNm	oz-in	g.cm ²	oz-in ²
17HA7 20 mm (0.79 in.)	17HA7402-06	78	11.05	0.65	6.6	7	5	0.71	20	0.08
17HA0 28 mm (1.10 in.)	17HA0403-44N	110	15.59	0.43	8	11	8	1.13	20	0.11
17HA4 34.3 mm (1.35 in.)	17HA4401-05N	220	31.18	0.87	3.1	3.6	12	1.70	38	0.21
	17HA4402-16N	250	35.43	0.5	20	23	12	1.70	38	0.21

- Uni-polar

Series & Length	Model Number	Holding Torque		Rated Current	Resistance per Phase	Inductance per Phase	Detent Torque		Rotor Inertia	
		mNm	oz-in	A	ohm	mH	mNm	oz-in	g.cm ²	oz-in ²
17HA7 20 mm (0.79 in.)	17HA7602	35	4.96	0.65	6.6	2.9	5	0.71	20	0.08
17HA0 28 mm (1.10 in.)	17HA0601N	60	8.50	0.43	8	4	8	1.13	20	0.11
17HA4 34.3 mm (1.35 in.)	17HA4605N	170	24.09	0.87	3.1	2.3	12	1.70	38	0.21
	17HA4606N	220	31.18	0.5	20	13	12	1.70	38	0.21

- Wiring Connection, Lead Wires, Schematic Diagrams & Stepping Sequence.....Page 62 - 64

Mechanical Dimension

Series	L	Mass
	mm (in.)	kg (lb.)
17HA7	20 (0.79)	0.12 (0.26)
17HA0	28 (1.10)	0.19 (0.42)
17HA4	34.3 (1.35)	0.23 (0.51)

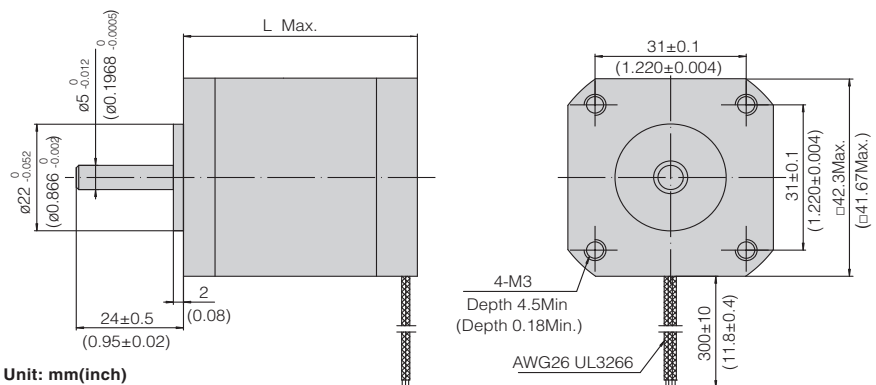

Dynamic Torque Curves

- Bi-polar

17HA7402-06

Conditions: Bi-polar Constant Current Driver
 Driver: AMA MS3540M
 Mode: Full Step

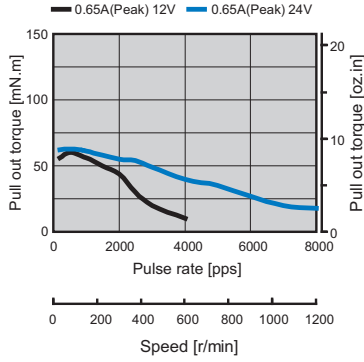

17HA0403-44N

Conditions: Bi-polar Constant Current Driver
 Driver: AMA MS3540M
 Mode: Full Step

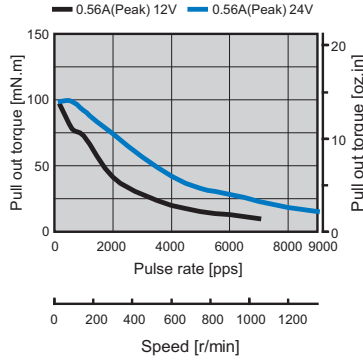

17HA4401-05N

Conditions: Bi-polar Constant Current Driver
 Driver: AMA MS3540M
 Mode: Full Step

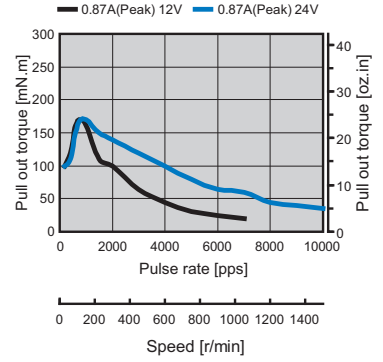

17HA4402-16N

Conditions: Bi-polar Constant Current Driver
 Driver: AMA MS3540M
 Mode: Full Step

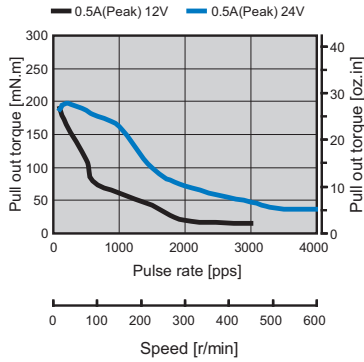

- Uni-polar

17HA7602

Conditions: Uni-polar Constant Current Driver
 Driver: AMA MSU3040M
 Mode: Full Step

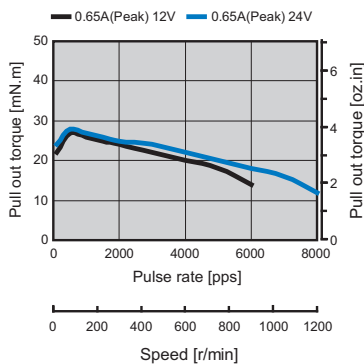

17HA0601N

Conditions: Uni-polar Constant Current Driver
 Driver: AMA MSU3040M
 Mode: Full Step

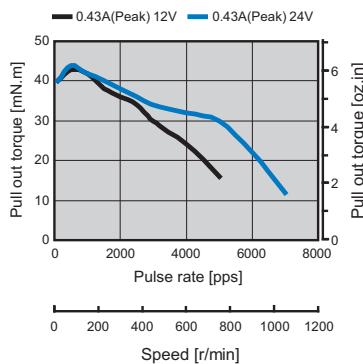

17HA4605N

Conditions: Uni-polar Constant Current Driver
 Driver: AMA MSU3040M
 Mode: Full Step

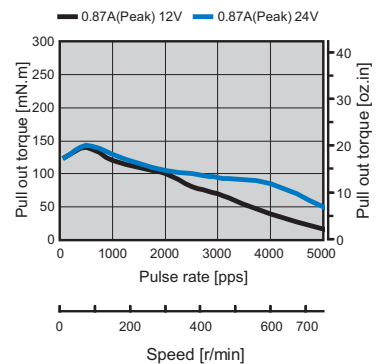

Dynamic Torque Curves

- Uni-polar

17HA4606N

Conditions: Uni-polar Constant Current Driver

Driver: AMA MSU3040M

Mode: Full Step

