

A PowerTrax™ Series slide assembly is truly a “System” not just a “Component”. The matched components used in PowerTrax™ Slides result in better system performance. When PowerTrax™ Slides Systems are used as sub-assemblies set-up and alignment time is reduced. PowerTrax™ Slide Systems are easier to specify and to order.

POWERTRAX™ SLIDE SYSTEM FEATURES

Precision carriage plates supplied with Series 130, 200 and MM Slide™, help prevent misaligned shafts and bearings.

Aluminum carriage plates include threaded steel inserts at key mounting locations.

Protective, non-corrosive finish on all exposed non-wear components.

PowerTrax™ Slide Systems have been engineered by Nook Industries for use in the following applications:

- Product Packaging
- Electronics Manufacturing
- Food Processing
- Machine Tool Equipment
- Component Assembly
- Material Handling
- Converting Processes
- Container Manufacturing
- Medical Equipment
- Textile Industry
- Automated Test Equipment

Contact Nook Industries, Inc. to discuss special requirements. Modifications include:

- Special screws (ground thread, precision rolled with preloaded nuts, high lead screws, metric lead screws, etc.)
- Protective boots in a variety of materials (neoprene, metallic, etc.)
- Special motor mounts (Servos, steppers, etc.)
- Custom carriage machining

SERIES 100 SLIDE SYSTEMS



PowerTrax™ Series 100 slide systems are pre-assembled and ready to mount. Series 100 slides consist of combinations of PowerTrax™ Linear Ball Bearing Pillow Blocks, HG shafting, carriage plates and shaft supports. Aluminum carriage plates include threaded steel inserts at key mounting locations. All exposed non-wearing components have a protective, corrosion resistant finish.



SERIES 200 SLIDE SYSTEMS

PowerTrax™ Series 200 slide systems are assembled slides which include:

- Linear Bearing pillow blocks
- Integrated end supports
- HG linear shafts
- Carriage plate
- PowerAc™ or PowerTrac™ Screw assembly

Many options are available for these slide systems. Different screw styles and leads, protective boots, special motor mounts and custom carriage plate machining is available. Contact Nook Industries, Inc. for assistance.

**MM SLIDE™
MINI SLIDE SYSTEMS**

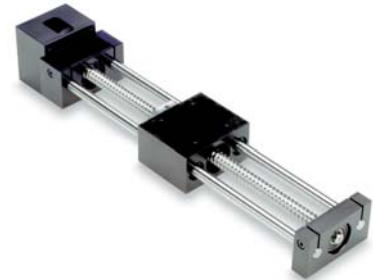

PowerTrax™ MM Slide™ are metric-dimensioned compact slide units. They utilize lightweight aluminum components and include an integrated carriage/pillow block assembly for a reduced overall height. A wide variety of screw diameters, leads and nut styles are available. These systems include:

- EXCEL™ linear bearings
- Integrated end supports
- HG linear shafts
- Carriage/pillow block assembly
- Lead screw assembly

PRECISION LINEAR SLIDE SYSTEMS TECHNICAL INTRODUCTION

212 - 12 - L 24 / 0750-0200 SRT / A34 / S

MODEL

MM SLIDE™

012 = Double Shaft End Supported System with Screw

SERIES 200

211 = Double Shaft End Supported System without Screw

251 = Double Shaft Fully Supported System without Screw

212 = Double Shaft End Supported System with Screw

252 = Double Shaft Fully Supported System with Screw

SERIES 300

302 = Double Shaft End Supported System without Screw

312 = Double Shaft Fully Supported System with Screw

SHAFT DIAMETER

Diameter of the shaft in sixteenth of an inch

MM SLIDE™

6 = 3/8 Inch

SERIES 200

8 = 1/2 Inch

12 = 3/4 inch

16 = 1 inch

24 = 1 1/2 inch

SERIES 300

8 = 1/2 Inch

12 = 3/4 inch

16 = 1 inch

OVERALL LENGTH

OAL Including end blocks, are inches preceded by an "L".

NOTE:

See description on the following pages for actual travel distance and standard lengths.

SCREW SPECIFICATION

Screw Size is matched to the diameter of the shaft. Select either an Acme or Ball Screw Part Number.

MM SLIDE™			SERIES 200			SERIES 300				
SHAFT Dia.	SPEEDY™ Screw Part #	CARRY™ Screw Part #	SHAFT Dia.	ACME SCREW Part #	BALL SCREW Part #	SHAFT Dia.	ACME SCREW Part #	BALL SCREW Part #		
6 (3/8")	11 x 60	12 x 4 12 x 5	8 (1/2")	1/2-1	0500-0200 SRT 0500-0500 SRT	8 (1/2")	3/8-2	0375-0125 SRT		
	13 x 70			1/2-2			3/8-4			
	14 x 8			1/2-5			3/8-5			
	14 x 18			1/2-10			3/8-6			
	14 x 30		3/4-10	3/8-8						
6 (3/8")	11 x 60	12 x 4 12 x 5	12 (3/4")	1000-0250 SRT	0750-0200 SRT 0750-0500 SRT		12 (3/4")		3/8-10	0500-0200 SRT 0500-0500 SRT
	13 x 70			1-1					3/8-12	
	14 x 8		1-10	3/8-16						
	14 x 18		1000-1000 SRT	1/2-1						
	14 x 30		1500-0250 SRT	1/2-2						
6 (3/8")	11 x 60	12 x 4 12 x 5	16 (1")	1500-0500 SRT	1500-0250 SRT 1500-0500 SRT 1500-1000 SRT 1500-1875 SRT 1500-0500 XPR	16 (1")	1/2-4	0750-0200 SRT 0750-0500 SRT		
	13 x 70			1-1/2-2			1/2-5			
	14 x 8			1-1/2-2/3			1/2-10			
	14 x 18			1-1/2-4			3/4-10			
	14 x 30			1-1/2-5						
6 (3/8")	11 x 60	12 x 4 12 x 5	24 (1-1/2")	1-1/2-10						

MOTOR ADAPTERS

MM SLIDE™

A23 = 23 Frame for the 6 (3/8")

00 = No motor adapter

SERIES 200

A23 = 23 Frame for the 8 (1/2") and 12 (3/4") Slide

A34 = 34 Frame size for 16 (1") Slide

A42 = 42 Frame size for 24 (1 1/2") Slide

00 = No motor adapter

SERIES 300

A23 = 23 Frame for the 8 (1/2") and 12 (3/4") Slide

A34 = 34 Frame size for 16 (1") Slide

00 = No motor adapter

MODIFIER LIST

ALWAYS S or M

S = Standard, no additional description or modification required

M = Modified, additional description required

B = Boot, the "L" dimension must be increased by .1" times travel in order to accommodate the retracted boot

CARRIAGE MOUNTING PLATES

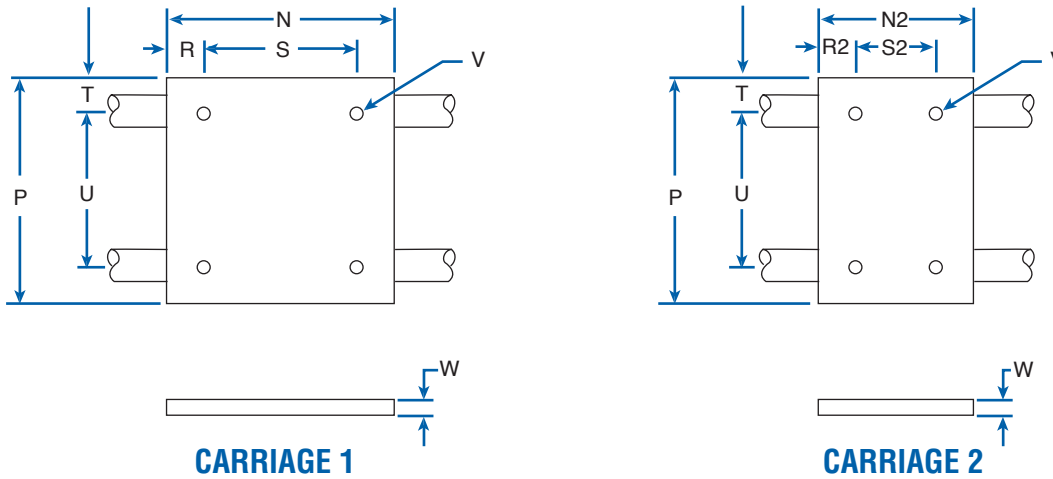

CARRIAGE MOUNTING PLATES

NOMINAL SHAFT DIA.	DIMENSION (inches)										
	CARRIAGE 1			COMMON TO CARRIAGE 1 & 2					CARRIAGE 2		
	N	R	S	P	T	U	V	W	N2	R2	S2
1/2	5.50	.500	4.50	5.50	1.125	3.25	1/4-20	.375	3.50	.50	2.50
3/4	7.50	.750	6.00	7.50	1.500	4.50	5/16-18	.50	4.50	.75	3.00
1	9.00	1.000	7.00	9.00	1.750	5.50	3/8-16	.50	6.00	1.00	4.00
1-1/2	13.00	1.500	10.00	13.00	2.500	8.00	1/2-13	.75	9.00	1.50	6.00

Material: Aluminum Alloy Black Anodized

SERIES 111: SINGLE SHAFT UNSUPPORTED SYSTEM

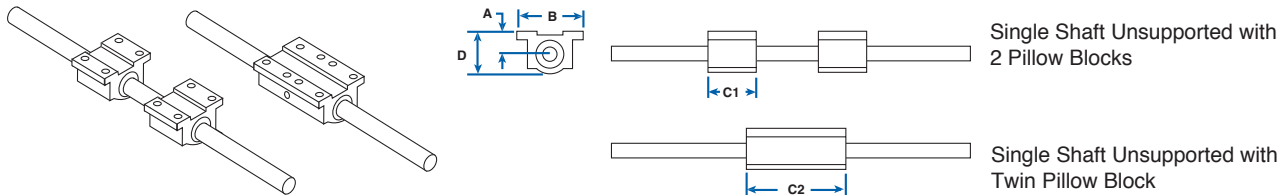

SINGLE SHAFT UNSUPPORT WITH 2 PILLOW BLOCKS

PART NO.	NOM. SHAFT DIA. (in.)	LOAD (lbf)* MAX/BLOCK	DIMENSION (inches)				PILLOW BLOCK**
			A ±.001	B	C1	D	
111-06-SXX	3/8	68	0.500	1.75	1.31	0.94	XEP-6
111-08-SXX	1/2	175	0.687	2.00	1.69	1.25	XEP-8
111-12-SXX	3/4	406	0.937	2.75	2.06	1.75	XEP-12
111-16-SXX	1	725	1.187	3.25	2.81	2.19	XEP-16
111-24-SXX	1-1/2	1,376	1.750	4.75	4.00	3.25	XEP-24

SINGLE SHAFT UNSUPPORTED WITH TWIN PILLOW BLOCKS

PART NO.	NOM. SHAFT DIA. (in.)	LOAD (lbf)* MAX/BLOCK	DIMENSION (inches)				PILLOW BLOCK**
			A ±.001	B	C2	D	
111-06-TXX	3/8	136	0.500	1.75	2.75	0.94	TEP-6
111-08-TXX	1/2	350	0.687	2.00	3.50	1.25	TEP-8
111-12-TXX	3/4	812	0.937	2.75	4.50	1.75	TEP-12
111-16-TXX	1	1,450	1.187	3.25	6.00	2.19	TEP-16
111-24-TXX	1-1/2	2,752	1.750	4.75	9.00	3.25	TEP-24

* Based on horizontal load, equally distributed to each bearing with a travel life of 2 million inches. ** See pages 231-232 for details. XX = shaft length - see page 241.

SERIES 121: SINGLE SHAFT END SUPPORTED SYSTEM

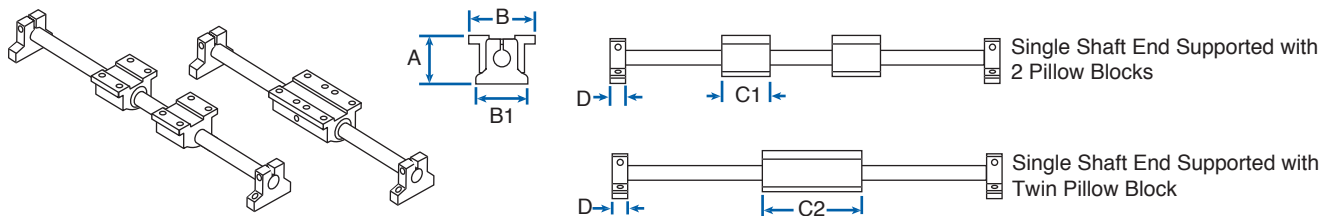

SINGLE SHAFT END SUPPORTED WITH 2 PILLOW BLOCKS

PART NO.	NOM. SHAFT DIA. (in.)	LOAD (lbf)* MAX/BLOCK	DIMENSION (inches)					PILLOW BLOCK**	END SUPPORT*
			A ±.003	B	B1	C1	D		
121-06-SXX	3/8	68	1.250	1.75	1.63	1.31	0.56	XEP-6	NSB-6
121-08-SXX	1/2	175	1.687	2.00	2.00	1.69	0.63	XEP-8	NSB-8
121-12-SXX	3/4	406	2.187	2.75	2.75	2.06	0.75	XEP-12	NSB-12
121-16-SXX	1	725	2.687	3.25	3.25	2.81	1.00	XEP-16	NSB-16
121-24-SXX	1-1/2	1,376	3.750	4.75	4.75	4.00	1.25	XEP-24	NSB-24

SINGLE SHAFT END SUPPORTED WITH TWIN PILLOW BLOCK

PART NO.	NOM. SHAFT DIA. (in.)	LOAD (lbf)* MAX/BLOCK	DIMENSION (inches)					MAX. STROKE LENGTH (in.)	PILLOW BLOCK**	END SUPPORT*
			A ±.003	B	B1	C2	D			
121-06-TXX	3/8	136	1.250	1.75	1.63	2.75	0.56	L-(3.88)	TEP-6	NSB-6
121-08-TXX	1/2	350	1.687	2.00	2.00	3.50	0.63	L-(4.75)	TEP-8	NSB-8
121-12-TXX	3/4	812	2.187	2.75	2.75	4.50	0.75	L-(6.00)	TEP-12	NSB-12
121-16-TXX	1	1,450	2.687	3.25	3.25	6.00	1.00	L-(8.00)	TEP-16	NSB-16
121-24-TXX	1-1/2	2,752	3.750	4.75	4.75	9.00	1.25	L-(11.50)	TEP-24	NSB-24

* Based on horizontal load, equally distributed to each bearing with a travel life of 2 million inches. ** See pages 231-232 for details. XX = shaft length - see page 241.

SERIES 131: SINGLE SHAFT FULLY SUPPORTED SYSTEM

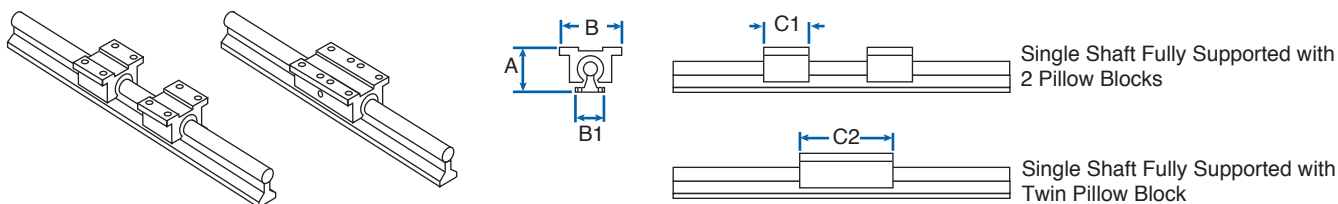

SINGLE SHAFT FULLY SUPPORTED WITH 2 PILLOW BLOCKS

PART NO.	NOM. SHAFT DIA. (in.)	LOAD (lbf)* MAX/BLOCK	DIMENSION (inches)				PILLOW BLOCK**
			A ±.003	B	C1	B1	
131-08-SXX	1/2	152	1.812	2.00	1.69	1.50	XEP-08-OPN
131-12-SXX	3/4	398	2.437	2.75	2.06	1.75	XEP-12-OPN
131-16-SXX	1	711	2.937	3.25	2.81	2.13	XEP-16-OPN
131-24-SXX	1-1/2	1,346	4.250	4.75	4.00	3.00	XEP-24-OPN

SINGLE SHAFT FULLY SUPPORTED WITH TWIN PILLOW BLOCK

PART NO.	NOM. SHAFT DIA. (in.)	LOAD (lbf)* MAX/BLOCK	DIMENSION (inches)				PILLOW BLOCK**
			A ±.003	B	C2	B1	
131-08-TXX	1/2	304	1.812	2.00	3.50	1.50	TEP-08-OPN
131-12-TXX	3/4	796	2.437	2.75	4.50	1.75	TEP-12-OPN
131-16-TXX	1	1,422	2.937	3.25	6.00	2.13	TEP-16-OPN
131-24-TXX	1-1/2	2,692	4.250	4.75	9.00	3.00	TEP-24-OPN

* Based on horizontal load, equally distributed to each bearing with a travel life of 2 million inches. ** See pages 231-232 for details. XX = shaft length - see page 241.

PRECISION LINEAR SLIDE SYSTEMS TECHNICAL DATA

SERIES 112: DOUBLE SHAFT UNSUPPORTED SYSTEM

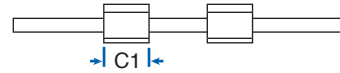
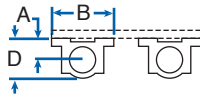
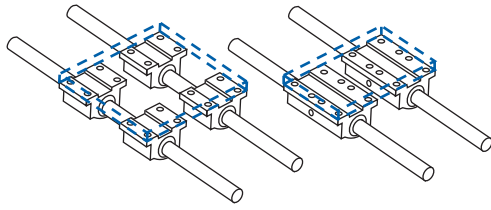

Double Shaft Unsupported with 4 Pillow Blocks

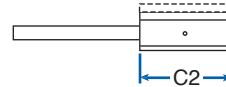

Double Shaft Unsupported with 2 Twin Pillow Blocks

DOUBLE SHAFT UNSUPPORTED WITH 4 PILLOW BLOCKS

PART NO.	NOM. SHAFT DIA. (in.)	LOAD (lbf)*		DIMENSION (inches)				PILLOW BLOCK**
		MAX/SYSTEM	MAX/BLOCK	A ±.001	B	C1	D	
112-06-SXX	3/8	272	68	0.500	1.75	1.31	0.94	XEP-6
112-08-SXX	1/2	700	175	0.687	2.00	1.69	1.25	XEP-8
112-12-SXX	3/4	1,624	406	0.937	2.75	2.06	1.75	XEP-12
112-16-SXX	1	2,900	725	1.187	3.25	2.81	2.19	XEP-16
112-24-SXX	1-1/2	5,504	1,376	1.750	4.75	4.00	3.25	XEP-24

DOUBLE SHAFT UNSUPPORTED WITH 2 TWIN PILLOW BLOCKS

PART NO.	NOM. SHAFT DIA. (in.)	LOAD (lbf)*		DIMENSION (inches)				PILLOW BLOCK**
		MAX/SYSTEM	MAX/BLOCK	A ±.001	B	C2	D	
112-06-TXX	3/8	272	136	0.500	1.75	2.75	0.94	TEP-6
112-08-TXX	1/2	700	350	0.687	2.00	3.50	1.25	TEP-8
112-12-TXX	3/4	1,624	812	0.937	2.75	4.50	1.75	TEP-12
112-16-TXX	1	2,900	1,450	1.187	3.25	6.00	2.19	TEP-16
112-24-TXX	1-1/2	5,504	2,752	1.750	4.75	9.00	3.25	TEP-24

* Based on horizontal load, equally distributed to each bearing with a travel life of 2 million inches. ** See pages 231-232 for details. XX = shaft length - see page 241.

SERIES 122: DOUBLE SHAFT END SUPPORTED SYSTEM

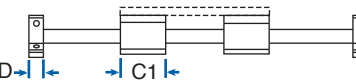
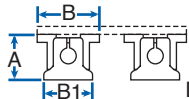
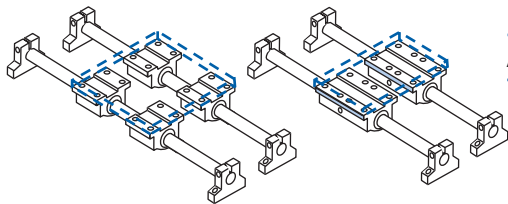

Double Shaft End Supported with 4 Pillow Blocks



Double Shaft End Supported with 2 Twin Pillow Blocks

DOUBLE SHAFT END SUPPORTED WITH 4 PILLOW BLOCKS

PART NO.	NOM. SHAFT DIA. (in.)	LOAD (lbf)*		DIMENSION (inches)					PILLOW BLOCK**	END SUPPORT*
		MAX/SYSTEM	MAX/BLOCK	A ±.003	B	B1	C1	D		
122-06-SXX	3/8	272	68	1.250	1.75	1.63	1.31	0.56	XEP-6	NSB-6
122-08-SXX	1/2	700	175	1.687	2.00	2.00	1.69	0.63	XEP-8	NSB-8
122-12-SXX	3/4	1,624	406	2.187	2.75	2.75	2.06	0.75	XEP-12	NSB-12
122-16-SXX	1	2,900	725	2.687	3.25	3.25	2.81	1.00	XEP-16	NSB-16
122-24-SXX	1-1/2	5,504	1,376	3.750	4.75	4.75	4.00	1.25	XEP-24	NSB-24

DOUBLE SHAFT END SUPPORTED WITH 2 TWIN PILLOW BLOCKS

PART NO.	NOM. SHAFT DIA. (in.)	LOAD (lbf)*		DIMENSION (inches)					MAX. STROKE LENGTH (in.)	PILLOW BLOCK**	END SUPPORT*
		MAX/SYSTEM	MAX/BLOCK	A ±.003	B	B1	C2	D			
122-06-TXX	3/8	272	136	1.250	1.75	1.63	2.75	0.56	L-(3.88)	TEP-6	NSB-6
122-08-TXX	1/2	700	350	1.687	2.00	2.00	3.50	0.63	L-(4.75)	TEP-8	NSB-8
122-12-TXX	3/4	1,624	812	2.187	2.75	2.75	4.50	0.75	L-(6.00)	TEP-12	NSB-12
122-16-TXX	1	2,900	1,450	2.687	3.25	3.25	6.00	1.00	L-(8.00)	TEP-16	NSB-16
122-24-TXX	1-1/2	5,504	2,752	3.750	4.75	4.75	9.00	1.25	L-(11.50)	TEP-24	NSB-24

* Based on horizontal load, equally distributed to each bearing with a travel life of 2 million inches. ** See pages 231-232 for details. XX = shaft length - see page 241.

The specifications and data in this publication are believed to be accurate and reliable. However, it is the responsibility of the product user to determine the suitability of Nook Industries products for a specific application. While defective products will be replaced without charge if promptly returned, no liability is assumed beyond such replacement.

SERIES 132: DOUBLE SHAFT FULLY SUPPORTED SYSTEM

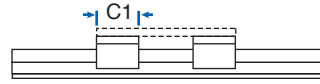
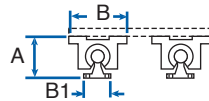
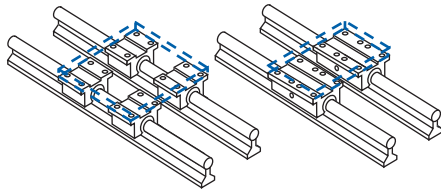

Double Shaft Fully Supported with 4 Pillow Blocks

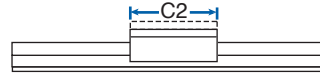

Double Shaft Fully Supported with 2 Twin Pillow Blocks

DOUBLE SHAFT FULLY SUPPORTED WITH 4 PILLOW BLOCKS

PART NO.	NOM. SHAFT DIA. (in.)	LOAD (lbf)*		DIMENSION (inches)				PILLOW BLOCK**
		MAX/SYSTEM	MAX/BLOCK	A ±.003	B	B1	C1	
132-08-SXX	1/2	608	152	1.812	2.00	1.50	1.69	XEP-8-OPN
132-12-SXX	3/4	1,584	398	2.437	2.75	1.75	2.06	XEP-12-OPN
132-16-SXX	1	2,844	711	2.937	3.25	2.13	2.81	XEP-16-OPN
132-24-SXX	1-1/2	5,384	1,346	4.250	4.75	3.00	4.00	XEP-24-OPN

DOUBLE SHAFT FULLY SUPPORTED WITH 2 TWIN PILLOW BLOCKS

PART NO.	NOM. SHAFT DIA. (in.)	LOAD (lbf)*		DIMENSION (inches)				PILLOW BLOCK**
		MAX/SYSTEM	MAX/BLOCK	A ±.003	B	B1	C2	
132-08-TXX	1/2	608	304	1.812	2.00	1.50	3.50	TEP-8-OPN
132-12-TXX	3/4	1,584	796	2.437	2.75	1.75	4.50	TEP-12-OPN
132-16-TXX	1	2,844	1,422	2.937	3.25	2.13	6.00	TEP-16-OPN
132-24-TXX	1-1/2	5,384	2,692	4.250	4.75	3.00	9.00	TEP-24-OPN

* Based on horizontal load, equally distributed to each bearing with a travel life of 2 million inches. ** See pages 231-232 for details. XX = shaft length - see page 241.

SERIES 113: DOUBLE SHAFT UNSUPPORTED SYSTEM WITH CARRIAGE

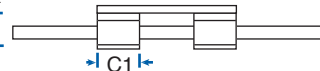
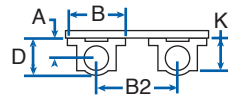
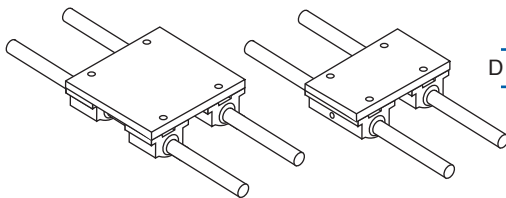

Double Shaft Unsupported with 4 Pillow Blocks and Carriage 1

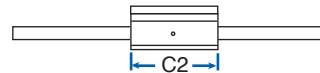

Double Shaft Unsupported with 2 Twin Pillow Blocks and Carriage 2

DOUBLE SHAFT UNSUPPORTED WITH 4 PILLOW BLOCKS AND CARRIAGE 1

PART NO.	NOM. SHAFT DIA. (in.)	LOAD (lbf)* MAX/SYSTEM	DIMENSION (inches)					PILLOW BLOCK**
			A ±.001	B	B2	C1	D	
113-08-SXX	1/2	700	0.687	2.00	3.25	1.69	1.25	XEP-8
113-12-SXX	3/4	1,624	0.937	2.75	4.50	2.06	1.75	XEP-12
113-16-SXX	1	2,900	1.187	3.25	5.50	2.81	2.19	XEP-16
113-24-SXX	1-1/2	5,504	1.750	4.75	8.00	4.00	3.25	XEP-24

DOUBLE SHAFT UNSUPPORTED WITH 2 TWIN PILLOW BLOCKS AND CARRIAGE 2

PART NO.	NOM. SHAFT DIA. (in.)	LOAD (lbf)* MAX/SYSTEM	DIMENSION (inches)					PILLOW BLOCK**
			A ±.001	B	B2	C2	D	
113-08-TXX	1/2	700	0.687	2.00	3.25	3.50	1.25	TEP-8
113-12-TXX	3/4	1,624	0.937	2.75	4.50	4.50	1.75	TEP-12
113-16-TXX	1	2,900	1.187	3.25	5.50	6.00	2.19	TEP-16
113-24-TXX	1-1/2	5,504	1.750	4.75	8.00	9.00	3.25	TEP-24

* Based on horizontal load, equally distributed to each bearing with a travel life of 2 million inches. ** See pages 231-232 for details. XX = shaft length - see page 241.

SERIES 123: DOUBLE SHAFT END SUPPORTED SYSTEM WITH CARRIAGE

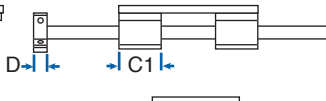
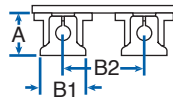
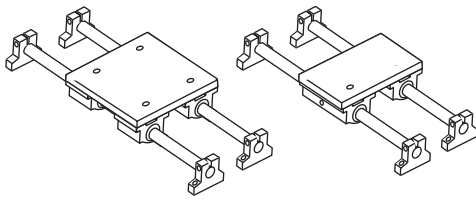

Double Shaft End Supported with 4 Pillow Blocks and Carriage 1



Double Shaft End Supported with 2 Twin Pillow Blocks and Carriage 2

DOUBLE SHAFT END SUPPORTED WITH 4 PILLOW BLOCKS AND CARRIAGE 1

PART NO.	NOM. SHAFT DIA. (in.)	LOAD (lbf)* MAX/SYSTEM	DIMENSION (inches)					PILLOW BLOCK**	END SUPPORT*
			A ±.003	B2	B1	C1	D		
123-08-SXX	1/2	700	1.687	3.25	2.00	1.69	0.63	XEP-8	NSB-8
123-12-SXX	3/4	1,624	2.187	4.50	2.75	2.06	0.75	XEP-12	NSB-12
123-16-SXX	1	2,900	2.687	5.50	3.25	2.81	1.00	XEP-16	NSB-16
123-24-SXX	1-1/2	5,504	3.750	8.00	4.75	4.00	1.25	XEP-24	NSB-24

DOUBLE SHAFT END SUPPORTED WITH 2 TWIN PILLOW BLOCKS AND CARRIAGE 2

PART NO.	NOM. SHAFT DIA. (in.)	LOAD (lbf)* MAX/SYSTEM	DIMENSION (inches)					MAX. STROKE LENGTH (in.)	PILLOW BLOCK**	END SUPPORT*
			A ±.003	B2	B1	C2	D			
123-08-TXX	1/2	700	1.687	3.25	2.00	3.50	0.63	L-(4.75)	TEP-8	NSB-8
123-12-TXX	3/4	1,624	2.187	4.50	2.75	4.50	0.75	L-(6.00)	TEP-12	NSB-12
123-16-TXX	1	2,900	2.687	5.50	3.25	6.00	1.00	L-(8.00)	TEP-16	NSB-16
123-24-TXX	1-1/2	5,504	3.750	8.00	4.75	9.00	1.25	L-(11.50)	TEP-24	NSB-24

* Based on horizontal load, equally distributed to each bearing with a travel life of 2 million inches. ** See pages 231-232 for details. XX = shaft length - see page 241.

SERIES 133: DOUBLE SHAFT FULLY SUPPORTED SYSTEM WITH CARRIAGE

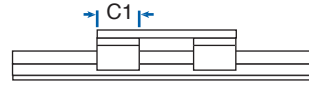
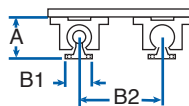
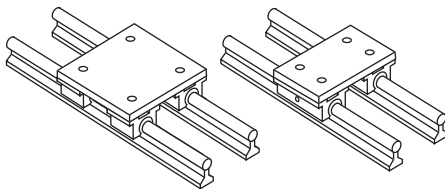

Double Shaft Fully Supported with 4 Pillow Blocks and Carriage 1

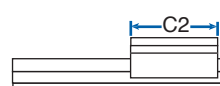

Double Shaft Fully Supported with 2 Twin Pillow Blocks and Carriage 2

DOUBLE SHAFT FULLY SUPPORTED WITH 4 PILLOW BLOCKS AND CARRIAGE 1

PART NO.	NOM. SHAFT DIA. (in.)	LOAD (lbf)* MAX/SYSTEM	DIMENSION (inches)				PILLOW BLOCK**
			A ±.003	B1	B2	C1	
133-08-SXX	1/2	608	1.812	1.50	3.25	1.69	XEP-8-OPN
133-12-SXX	3/4	1,584	2.437	1.75	4.50	2.06	XEP-12-OPN
133-16-SXX	1	2,844	2.937	2.13	5.50	2.81	XEP-16-OPN
133-24-SXX	1-1/2	5,384	4.250	3.00	8.00	4.00	XEP-24-OPN

DOUBLE SHAFT FULLY SUPPORTED WITH 2 TWIN PILLOW BLOCKS AND CARRIAGE 2

PART NO.	NOM. SHAFT DIA. (in.)	LOAD (lbf)* MAX/SYSTEM	DIMENSION (inches)				PILLOW BLOCK**
			A ±.003	B1	B2	C2	
133-08-TXX	1/2	608	1.812	1.50	3.25	3.50	TEP-8-OPN
133-12-TXX	3/4	1,584	2.437	1.75	4.50	4.50	TEP-12-OPN
133-16-TXX	1	2,844	2.937	2.13	5.50	6.00	TEP-16-OPN
133-24-TXX	1-1/2	5,384	4.250	3.00	8.00	9.00	TEP-24-OPN

* Based on horizontal load, equally distributed to each bearing with a travel life of 2 million inches. ** See pages 231-232 for details. XX = shaft length - see page 241.

**SERIES 212: DOUBLE SHAFT END SUPPORTED SYSTEM
WITH BALL SCREW ASSEMBLY AND CARRIAGE**

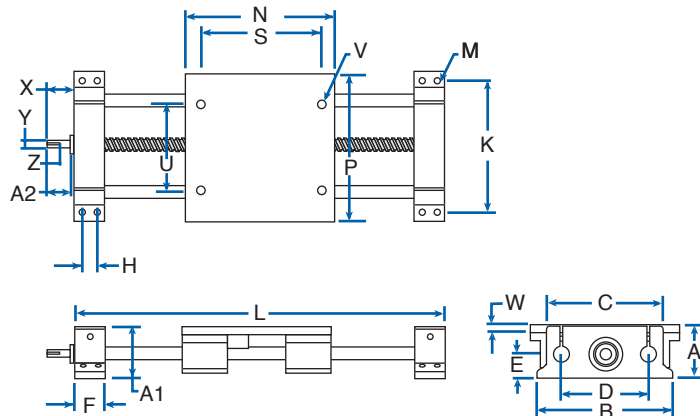

BENEFITS

- Adaptable to any drive system
- Flexible design
- Use where end supported systems are needed
- Pre-aligned, easy installation

COMPONENTS

- 4 Linear bearing pillow blocks
- 2 Integrated end supports
- 2 HG linear shafts
- 1 carriage
- 1 ball screw assembly

DOUBLE SHAFT END SUPPORT SYSTEM WITH BALL SCREW ASSEMBLY AND CARRIAGE

PART NO.	NOM. SHAFT DIA.	LOAD (lbf)*	BALL SCREW DIA.**	DIMENSION (inches)												MIN. "L" DIMENSION (in.)
				A ± .003	A1	B	C	D	E	F	H ±.010	K ±.010	M			
													BOLT	HOLE		
212-08-LXX	1/2	700	1/2	2.187	2.38	5.30	4.25	3.25	1.125	1.50	.75	4.80	#8	.19	TRAVEL+8.50	
212-12-LXX	3/4	1,624	3/4	2.937	2.88	7.20	6.00	4.50	1.500	2.00	1.00	6.70	#10	.22	TRAVEL+11.50	
212-16-LXX	1	2,900	1	3.437	3.45	8.75	7.25	5.50	1.750	2.20	1.20	8.00	1/4	.28	TRAVEL+13.40	
212-24-LXX	1-1/2	5,504	1-1/2	5.000	4.97	13.00	10.75	8.00	2.500	2.80	1.50	12.00	5/16	.34	TRAVEL+18.60	

* Based on horizontal load, equally distributed to each bearing with a travel life of 2 million inches. XX = shaft length - see page 241.

**Refer to page 248 for screw selection.

MOUNTING CARRIAGE TOP FOR 212 & 252

PART NO.	DIMENSION (inches)					
	N	P	S	U	V	W
2X2-08-LXX	5.50	5.50	4.50	3.25	1/4-20	.38
2X2-12-LXX	7.50	7.50	6.00	4.50	5/16-18	.50
2X2-16-LXX	9.00	9.00	7.00	5.50	3/8-16	.50
2X2-24-LXX	13.00	13.00	10.00	8.00	1/2-13	.75

SCREW & SHAFT EXTENSION FOR 212 & 252

PART NO.	DIMENSION (inches)				
	Screw Size	X	Y	Z	A2
2X2-08-LXX	0500-0500 SRT	1.00	.250	.51 x .095	.665
2X2-12-LXX	0750-0200 SRT	1.50	.500	.81 x .140	1.02
2X2-16-LXX	1000-1000 SRT	1.74	.625	1.03 x .188	1.26
2X2-24-LXX	1500-1000 SRT	2.32	.750	1.41 x .188	1.657

PRECISION LINEAR SLIDE SYSTEMS TECHNICAL DATA

SERIES 252 SLIDE SYSTEMS

SERIES 252: DOUBLE SHAFT FULLY SUPPORTED SYSTEM WITH END SUPPORTS, BALL SCREW ASSEMBLY AND CARRIAGE

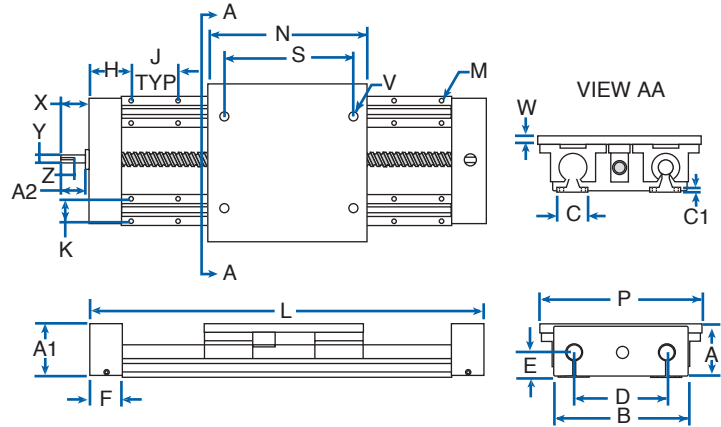

BENEFITS

- Adaptable to any drive system
- Flexible design
- Use where fully supported systems are needed
- Pre-aligned, easy installation

COMPONENTS

- 4 Linear bearing pillow blocks (open)
- 2 Integrated end supports
- 2 HG linear shafts
- 1 carriage, 1 ball screw assembly
- 2 shaft support rails

DOUBLE SHAFT FULLY SUPPORTED SYSTEM WITH END SUPPORTS, BALL SCREW ASS'Y & CARRIAGE

PART NO.	NOM. SHAFT DIA.	LOAD (lbf)*	BALL SCREW	A ±.003	DIMENSION (inches)												MIN. "L" DIMENSION (in.)
					A1	B	D	E	F	C	C1	**H	J±.010	K±.010	M		
															BOLT	HOLE	
252-08-LXX	1/2	608	.50 - .50	2.187	2.13	4.25	3.25	1.125	1.50	1.50	.187	2.00	4.00	1.00	#6	.17	TRAVEL+8.50
252-12-LXX	3/4	1,584	.75 - .20	2.938	2.75	6.00	4.50	1.500	2.00	1.75	.250	3.00	6.00	1.25	#10	.22	TRAVEL+11.50
252-16-LXX	1	2,844	1.00 - 1.00	3.438	3.25	7.25	5.50	1.750	2.20	2.13	.250	3.00	6.00	1.50	1/4	.28	TRAVEL+13.40
252-24-LXX	1-1/2	5,384	1.50 - 1.00	5.000	4.88	10.75	8.00	2.500	2.80	3.00	.375	4.00	8.00	2.25	3/8	.41	TRAVEL+18.60

*Based on horizontal load, equally distributed to each bearing with a travel life of 2 million inches

** For 18", 30" & 42" std. lengths, H=3.00
If non-standard length "H" is symmetrical

DOUBLE SHAFT SYSTEM STANDARD LENGTH FOR 212 & 252

PART NO.	18"	24"	30"	32"	36"	40"	42"	48"	54"	56"	60"	64"	66"	72"
2X2-08-LXX	■	■	■		■		●	●						
2X2-12-LXX	■	■	■		■		■	■						
2X2-16-LXX	■	■	■		■		■	■	■		■		■	■
2X2-24-LXX		■		■		■		■		■		■		■

● System 252 only

PRECISION LINEAR SLIDE SYSTEMS TECHNICAL DATA

SERIES 302: TWIN SHAFT FULLY SUPPORTED SYSTEM WITH CARRIAGE

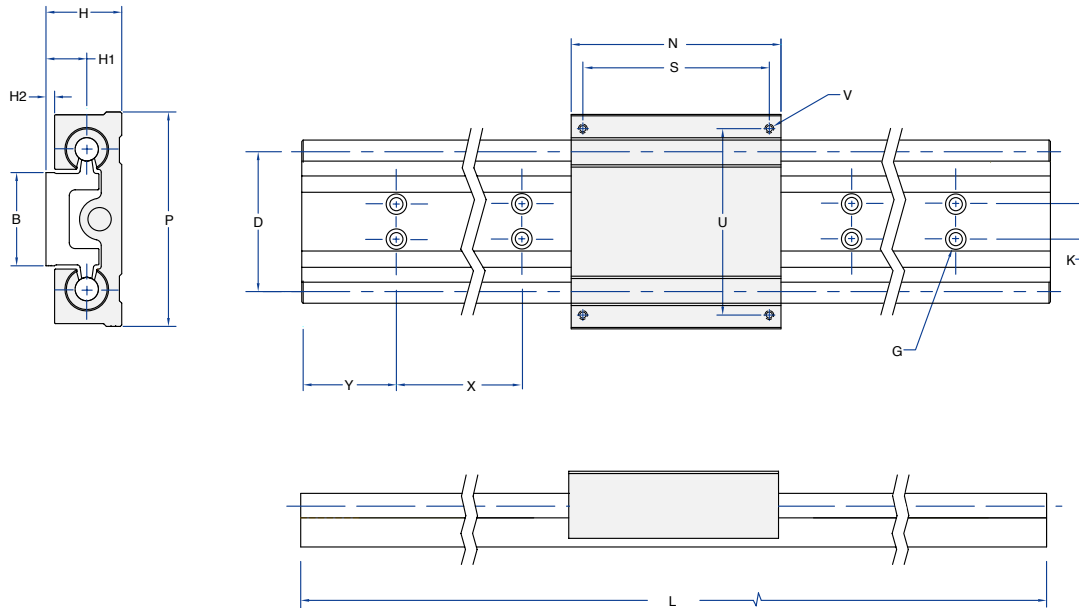

BENEFITS

- Ready-to-use system support
- Fully supported
- Pre-aligned for accuracy and ease of use
- Capable of carrying load in every direction and movement about all axes
- Adaptable to any drive system

COMPONENTS

- One integrated rail with two precision shafts
- One carriage with four open ball bearings

TWIN SHAFT FULLY SUPPORTED SYSTEM WITH CARRIAGE

PART NO.	NOM. SHAFT DIA.	B	P	H	N	H1	H2	D	S	U	V	L*		y†	X	K	G for
												min	max				
302-08-LXX	0.5	2	4.6	1.625	4.5	0.875	0.195	3	4	4	#10-32	12	48	2	4	0.75	1/4 BOLT
302-12-LXX	0.75	2.63	6.1	2.125	6	1.125	0.195	4	5.25	5.25	1/4-20	18	72	3	6	1	5/16 BOLT
302-16-LXX	1	3.25	7.6	2.625	7.5	1.375	0.185	5	6.75	6.75	5/16-18	18	96	3	6	1.25	3/8 BOLT

* Length increases by a multiple of "X" up to the maximum length. For longer systems, or systems with non-standard lengths, please inquire. XX=shaft length

† If non-standard length "Y" is symmetrical

PRECISION LINEAR SLIDE SYSTEMS TECHNICAL DATA

**SERIES 312: TWIN SHAFT FULLY SUPPORTED SYSTEM
WITH END SUPPORT, SCREW ASSEMBLY AND CARRIAGE**

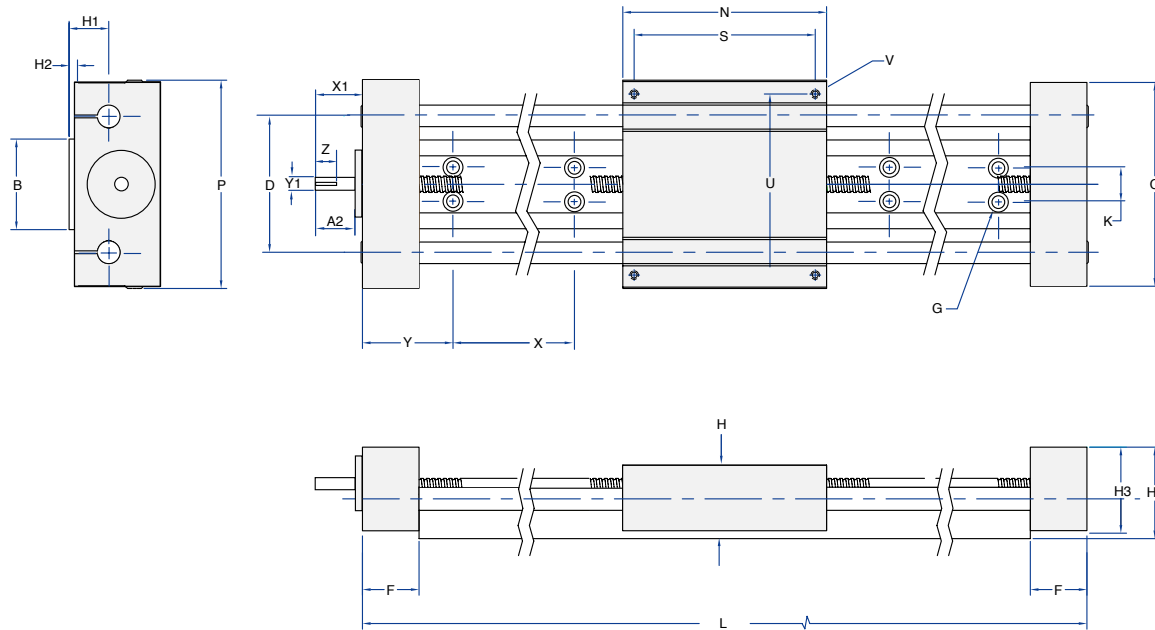

BENEFITS

- Ready-to-use system support
- Fully supported
- Pre-aligned for accuracy and ease of use
- Capable of carrying load in every direction and movement about all axes
- Integrated ball screw drive with standardized motor mount interface

COMPONENTS

- One integrated rail with two precision shafts
- One carriage with four open ball bearings
- One ball screw assembly
- Two end supports with bearings and motor interface.

TWIN SHAFT FULLY SUPPORTED SYSTEM WITH END SUPPORT, SCREW ASS'Y & CARRIAGE

PART NO.	NOM. SHAFT DIA.	BALL* SCREW DIA.	B	P	H	N	H1	H2	H3	H4	C	D	S	U	V	F	L**		Y†	X	K	G for
																	min	max				
312-08-LXX	0.5	3/8	2	4.6	1.625	4.5	0.875	0.195	1.9	2.02	4.5	3	4	#10-32	2	1.25	12	48	2	4	0.75	1/4 BOLT
312-12-LXX	0.75	1/2	2.63	6.1	2.125	6	1.125	0.195	2.37	2.62	6	4	5.25	1/4-2	3	1.5	18	72	3	6	1	5/16 BOLT
312-16-LXX	1	3/4	3.25	7.6	2.625	7.5	1.375	0.185	3.37	3.49	7	5	6.75	5/16-18	3	2	18	96	3	6	1.25	3/8 BOLT

XX=shaft length "L"

*Refer to page 248 for screw selection.

**Length increases by a multiple of "X" up to the maximum length. For longer systems, or systems with non-standard lengths, please inquire.

† If non-standard length "Y" is symmetrical.

SHAFT EXTENSION FOR 312

PART NO.	DIMENSION (inches)			
	X1	Y1	Z	A2
312-08	0.875	0.186	0.34 x 0.063	0.500
312-12	1.00	0.250	0.51 x 0.095	0.665
312-16	1.50	0.500	0.81 x 0.140	1.02

MM SLIDE™ DOUBLE SHAFT END SUPPORTED SYSTEM
WITH SCREW ASSEMBLY AND CARRIAGE

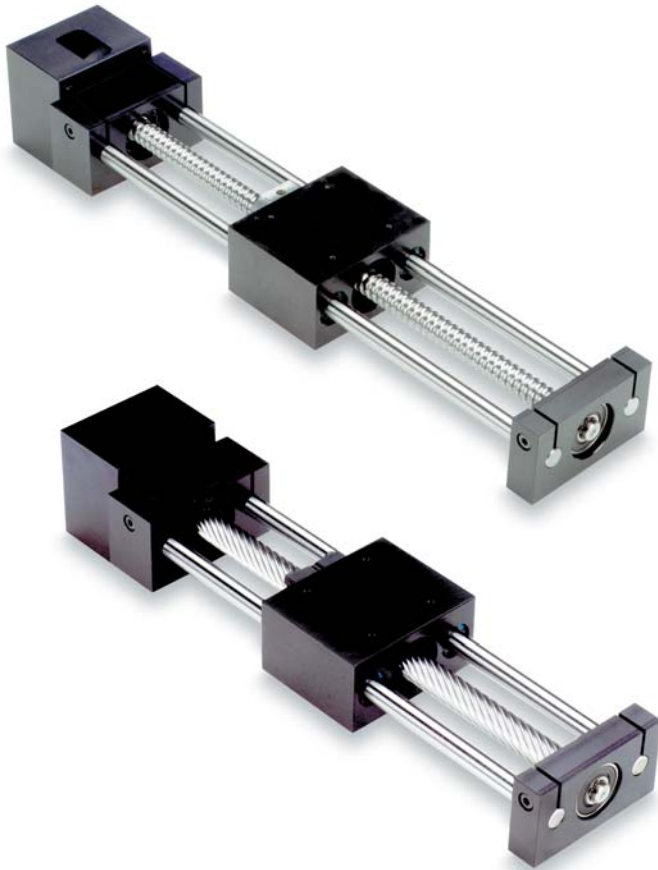

MM SLIDE™
SYSTEM FEATURES:

- The right solution for accurate positioning in limited space applications.
- Lightweight rigid aluminum construction provides high system strength and stiffness.
- Carriage plate includes hole patterns for easy payload integration or X-Y axis mounting.
- A wide variety of metric screw diameters, leads and nut styles are available to accommodate a wide range of performance requirements.
- Adaptable motor mounts provide flexibility in motor/control options.
- MM Slide™ includes one carriage/linear bearing block assembly (contains 4 EXCEL™ linear bearings), two integrated end supports, two HG linear shafts and one lead screw assembly.

PRECISION LINEAR SLIDE SYSTEMS TECHNICAL DATA

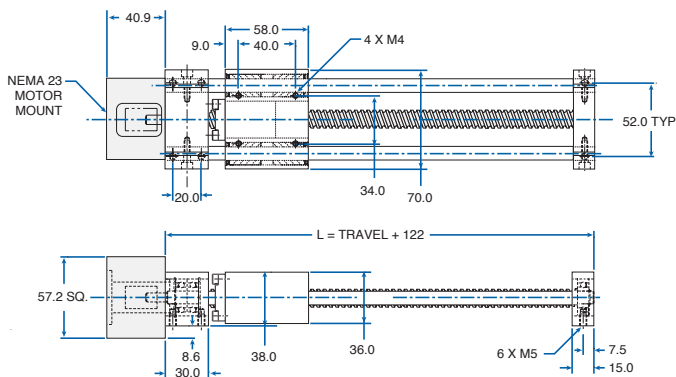

MM SLIDE SCREW SELECTION

SLIDE PART NO.	Nominal Shaft Dia. (mm)	Load (N)	Metric Screw	Page	L Max. (mm)
012-06-LXX	9.5	1174	Speedy 11 x 60	55	525
			Speedy 13 x 70	58	
			Speedy 14 x 8	59	
			Speedy 14 x 18	59	
			Speedy 14 x 30	59	
			Carry 12 x 4	158	
Carry 12 x 5	158				

XX=OAL [mm]

MOTOR ADAPTERS: SERIES 212, 252 and MM SLIDE™

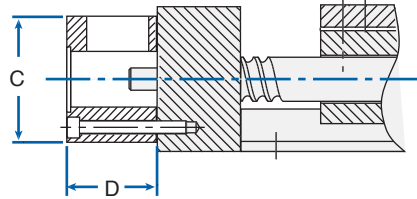
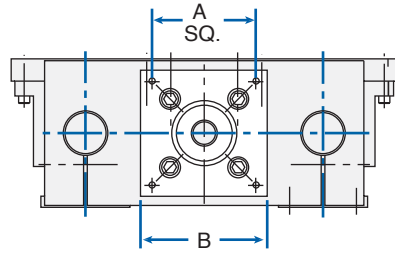

PowerTrax™ Slide System Motor Adapters allow for direct connection of a motor to a slide. Custom configurations are available, contact Nook Industries.

- Coupling is included
- Available for Series 212, 252, 312 and MM Slide™
- Aluminum construction

MOTOR ADAPTORS FOR 212, 252 & 312					
SLIDE PART NO.	Frame Size	DIMENSION (inches)			
		A	B	C	D
-08	23	1.86	2.25	2.25	1.65
-12	23	1.86	2.25	2.25	1.85
-16	34	2.74	3.25	3.25	2.75
-24	42	3.50	4.25	4.25	2.98

MOTOR ADAPTORS FOR MM SLIDE™					
SLIDE PART NO.	Frame Size	DIMENSION (mm)			
		A	B	C	D
012-06	23	47.25	57.2	57.2	40.9

Contact Nook Industries for additional sizes.

BELLOW BOOTS: SERIES 212 and 252

PowerTrax™ Slide System Bellows Boots protect slide components from contaminants. Custom configurations are available, contact Nook Industries, Inc.

- Available for Series 212 and 252
- PVC coated nylon
- Boot is fastened to the end blocks and carriage plate with hook and loop fasteners.

NOTE: Travel must be adjusted to accommodate retracted boot. Calculation per each boot is:
Retracted Boot = ("Travel" x .14")+.25

EXAMPLE 212-08-LXX with 24" Travel:

$$\begin{aligned} \text{"L"} &= (\text{Travel} + 8.5") + \text{Ret. Boot} + \text{Ret. Boot} \\ 39.7" &= (24" + 8.5") + 3.6" + 3.6" \end{aligned}$$

(See page 228-229 for 212 and 252 Series min "L" dimension.)

