



**PRECISION BALL SPLINE ASSEMBLIES
TECHNICAL INTRODUCTION**

195-200

- Glossary and Technical Data 195-198
- Lubricant 198
- Life Expectancy and Critical Speed Charts 199-200

INCH BALL SPLINES TECHNICAL DATA

201-204

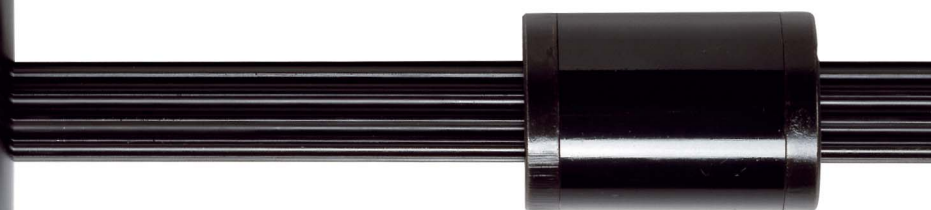

**PowerTorq™ Precision
Ball Spline Assemblies**

PowerTorq™ Ball Splines are convenient and efficient devices that allow friction free linear motion while transmitting torque. Because of their reliability and high efficiency, they are utilized to replace conventional

splines. In a ball spline assembly, recirculating bearing balls carry the load between the rotating member (inner race) and the rotating/translating member (outer race).

BALL SPLINE TERMS

ACTIVE CIRCUITS

The closed path that the bearing balls follow through the outer race is referred to as a circuit. The number of potential circuits varies with the diameter of the spline shaft. When a circuit is loaded with bearing balls, it is referred to as an “active circuit”. PowerTorq™ Ball Splines may have three, six or eight active circuits. (SEE FIG. 1)

FIG. 1

3 CIRCUIT

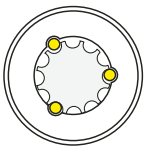

6 CIRCUIT

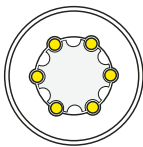

RETURN GUIDES

The outer race component through which the bearing balls are recirculated is referred to as the return guide. PowerTorq™ outer races are available with stamped return guides or high performance solid return guides.

BALL CIRCLE DIAMETER

The ball circle diameter is the diameter of the circle generated by the center of the bearing balls when in contact with the inner and outer race.

LAND DIAMETER

The land diameter is the outside diameter of the inner race. This diameter is less than the ball circle diameter.

ROOT DIAMETER

The root diameter is the diameter of the inner race measured at the bottom of the groove. This is the diameter used for critical speed calculations.

STRAIGHTNESS

Although PowerTorq™ Ball Splines are manufactured from straight, cylindrical material, internal stresses may cause the material to bend. When ordering random lengths or cut material without end machining, straightening is recommended. Handling or machining of splines can also cause the material to bend. Before, during and after machining, additional straightening may be required.

When ordering splines with machined ends from Nook Industries, the following straightness tolerances can be expected:

PowerTorq™ Ball Splines are straight within .010 inch/foot when shipped from the factory, and do not exceed .030 inch in any 6 foot section. Twist is limited to .015" per foot at the ball circle diameter.

LIFE

A ball spline assembly uses rolling elements to carry a load similar to an anti-friction (ball) bearing. These elements do not wear, when properly lubricated, during normal use. Therefore, ball spline life is predictable and is determined by

calculating the fatigue failure of the components.

Proper lubrication, regular maintenance, and operation within specified limits will allow PowerTorq™ Ball Splines to operate to the predicted life. See page 199 for life calculations.

FRICITION

The use of rolling elements in a PowerTorq™ Ball Spline result in a low coefficient of friction.

ROTATIONAL LASH

Backlash or lash is the relative rotational movement of an outer race with no rotation of the inner race (or vice versa). Rotational backlash for the PowerTorq™ Ball Splines is limited to a range of .005 to .009" at the ball circle diameter.

SELECTIVE FIT

When less than standard lash is required and a preloaded outer race cannot be used, outer races can be custom-fit to a specific inner race with bearing balls selected to minimize rotational (angular) lash.



LOAD DEFINITIONS

DYNAMIC TORQUE LOAD

The torque load which, when applied to the ball spline assembly, will allow a minimum life of 1,000,000 inches of travel.

STATIC TORQUE LOAD

The maximum torque load-including shock-that can be applied to the spline assembly without damaging the assembly.

OVERTURNING LOAD

A load that rotates the outer race around the longitudinal axis of the inner race. (SEE FIG. 2)

FIG. 2

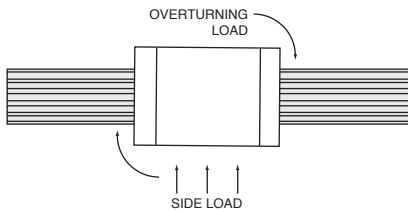

SIDE LOAD

A load that is applied radially to the outer race. (SEE FIG. 2)

CAUTION - Although a side load will not prevent the ball spline from operating, the outer race is not designed to operate with a side load, such as those generated from pulleys, drive belts or misalignment.

PRELOAD

Preload is a load introduced between an outer race and screw assembly that eliminates radial movement. Preloaded assemblies provide zero backlash for excellent repeatability and increased system stiffness.

OPTIONAL STANDARD KEYWAYS

Typically, outer races are mounted by machining a keyway into the outer race, inserting a key, and then sliding the outer race into a keyed bore. Standard machined keyways are available. See product pages 201-204 for details.

TRANSFERRING OUTER RACES FROM SHIPPING ARBOR

STANDARD RACES

PowerTorq™ Ball Spline outer races are shipped on arbors. Transferring the outer race from the arbor to the ball spline can be achieved by placing the arbor against the end of the spline and carefully sliding the outer race onto the inner race.

If the I.D. of the arbor is not able to slip over the O.D. of the end journal, apply tape to the journal to bring the O.D. up to the root diameter. The outer race can then be transferred across the taped journal onto the ball spline.

CAUTION - REMOVAL OF THE ARBOR FROM THE OUTER RACE WILL RESULT IN THE LOSS OF THE BEARING BALLS.

NOTE - The set screw is used for transportation only and needs to be completely removed after installation.

POWERTORQ™ MATERIAL SPECIFICATION



PowerTorq™ inner races are made of high quality 4150 alloy steel, induction hardened to Rc 56-60. PowerTorq™ outer races are made of hardened steel with ball tracks heat treated to Rc 58-60. PowerTorq™ ball spline inner and outer races are protected with a black oxide finish.



LUBRICATION

Proper and frequent lubrication must be provided to achieve predicted service life. A 90% reduction in the ball spline life should be anticipated when operating without lubricants.

Standard lubrication practices for antifriction bearings should be followed when lubricating ball splines. A light oil or grease (lithium-based) is suitable for most applications. Lubricants containing solid additives such as moly-disulfide or graphite should not be used.

E-900, Nook Lubricant, is oil that has been developed specifically for ball screws and ball splines and is available as a spray or liquid.

Lubrication intervals are determined by the application. It is required that spline assemblies are lubricated often enough to maintain a film of lubricant on the inner race.

TEMPERATURE

PowerTorq™ Ball Splines will operate between -65°F and 300°F with proper lubrication.

END MACHINING

To obtain optimum performance of your ball spline assembly, it is recommended that the machining be performed at the Nook Industries factory. Splines may be purchased machined to your specifications.

Annealed ends can be provided on SRR splines to facilitate end machining of journals.

END FIXITY

End fixity refers to the method by which the ends of the spline are supported. See the Ball Screw technical section for a further explanation of end fixity, page 86-87.

CRITICAL SPEED

The speed that excites the natural frequency of the spline inner race is referred to as the critical speed. Resonance at the natural frequency of the inner race will occur regardless of orientation (vertical, horizontal, etc.).

The critical speed will vary with the diameter, unsupported length, end fixity and rpm. Since critical speed can also be affected by shaft straightness and assembly alignment, it is recommended the maximum speed be limited to 80%

of the calculated value. The formula used to calculate critical speed is found on page 200.

Also, the critical speed chart, provided in the catalog, can be used to quickly determine the minimum diameter applicable to a design.

E-900 LUBRICANT PROTECTS AGAINST INTER-BALL FRICTION, WEAR, CORROSION AND OXIDATION.

E-900 Ball Screw Lubricant may be used on PowerTorq™ Ball Splines. E-900 will provide a lasting film for wear protection and resistance to corrosion. With an operating range of -65° to +375°F, E-900 has low rolling friction characteristics and helps reduce inter-ball friction in ball spline assemblies.

For optimum results, the ball spline assembly should be in good repair and free of dirt and grease. Used regularly, E-900 will extend the life of ball spline assemblies. It should be applied generously on the entire length of the spline.



E-900 SPRAY CAN	
PART NAME	E-900
NET CONTENTS PER UNIT	12 oz.
PART # NLU-1003	1 CAN weight of 1 lb.
PART # NLU-2003	1 CASE with 12 cans total weight of 13 lbs.

E-900 LIQUID	
PART NAME	E-900L
NET CONTENTS PER UNIT	32 oz.
PART # NLU-1004	1 BOTTLE weight of 32 oz.
PART # NLU-2004	1 CASE with 12 Quarts total weight of 25 lbs. 5 oz.

The selection of the correct inner and outer race involves two interrelated factors. A change in one may affect the other. Before attempting to choose the size of a ball spline, the designer must know the equivalent torque measured in pound-inches, the required life measured in linear inches of travel, speed measured in revolutions per minute and length between bearing supports measured in inches.

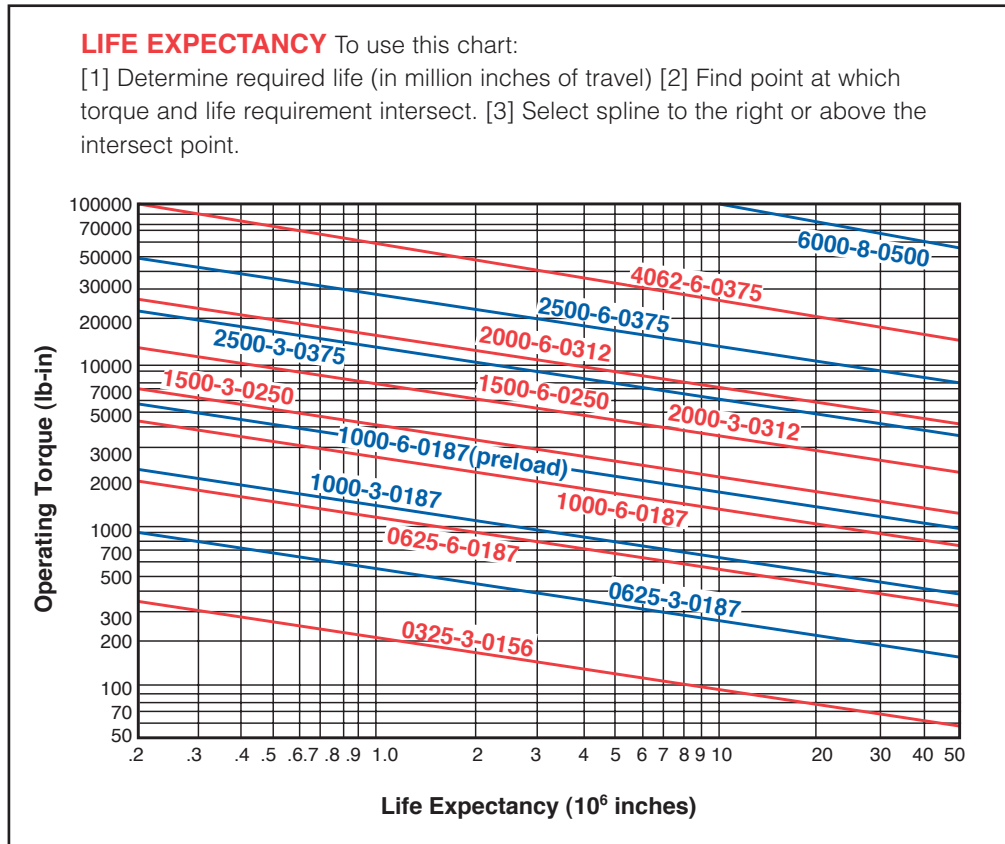

LIFE EXPECTANCY

Use the chart to determine the correct size spline which will give the life required at the equivalent torque. The chart relates life to torque.

When the torque is relatively constant over the entire stroke, use the highest torque value to select an outer race.

For applications where the torques vary significantly, an equivalent torque can be calculated using the following formula:

$$T_m = \sqrt[3]{\frac{\%_1(T_1)^3 + \%_2(T_2)^3 + \%_3(T_3)^3 + \dots + \%_n(T_n)^3}{100}}$$

WHERE:

- T_m = equivalent load
- T_n = each increment of load
- %_n = percent of stroke at load T_n

FOR EXAMPLE:

- T₁ = 150 pound-inch
- T₂ = 225 pound-inch
- T₃ = 725 pound-inch

$$T_m = \sqrt[3]{\frac{30(150)^3 + 45(225)^3 + 25(725)^3}{100}}$$

T_m = 466 pound-inch

The life required is determined by multiplying the total stroke in inches by the total number of strokes required for the designed life of the equipment.

CRITICAL SPEED To use this chart:

- [1] Determine the maximum RPM [2] Determine the maximum length between bearings.
- [3] Determine end fixity. [4] Find point at which length and speed intersect.
- [5] Choose spline direction to the right or above the intersecting point.

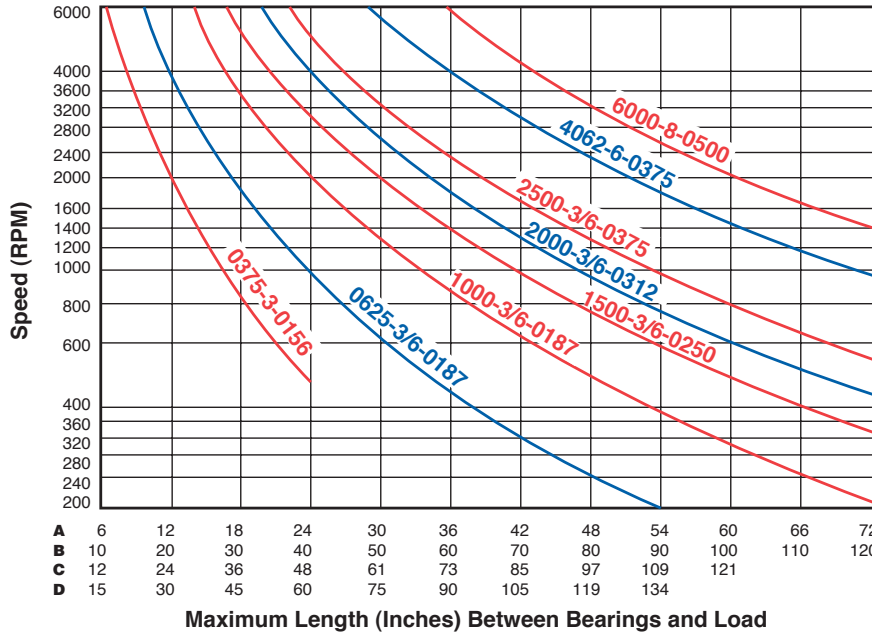

see page 87 for a description on "A-B-C-D" end fixity

CRITICAL SPEED

The final factor to verify is the critical speed. The following formula is used to calculate critical speed in r.p.m.

$$N = \frac{C_s \times 4.76 \times 10^6 \times d}{L^2}$$

- Where N = Critical speed
- d = Root diameter of inner race
- L = Length between bearing supports
- C_s = .36 for one end fixed, one end free
- 1.00 for both ends simple
- 1.47 for one end fixed, one end simple
- 2.23 for both ends fixed

Critical speed can also be affected by shaft straightness and assembly alignment, it is recommended the maximum speed be limited to 80% of the calculated value.

<h1>0375-3-0156</h1> <p> 0.375 Nominal Size 0.200 Root Diameter 0.156 Nominal Ball Diameter 0.31 Inner Race Weight (lbs./ft.) SOR Stamped Ball Returns HPR Cast Ball Returns </p>	Ball Spline Inner Race Length	PART NUMBERS
	2 FT.	SRR7547
	Custom lengths available up to 2'.	

SOR and HPR Ball Spline Outer Races 54 bearing balls total per outer race

PRODUCT SPECIFICATIONS	STANDARD		HIGH PERFORMANCE	
	3	6	3	6
Active Circuits	3	6	3	6
Dynamic Torque (in.-lb.)	200	—	200	—
Static Torque (in.-lb.)	626	—	626	—
Optional Keyway	$\frac{3}{16} \times \frac{3}{32} \times 1.00$	—	$\frac{3}{16} \times \frac{3}{32} \times 1.00$	—
Outer Race Weight (lbs.)	0.27	—	0.32	—
Outer Race Part Number	SOR6900	—	HPR6900	—

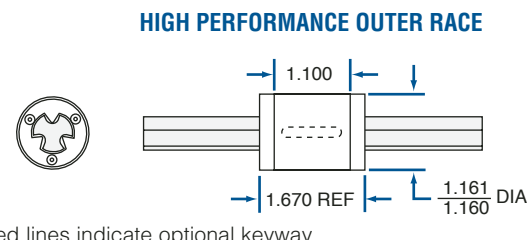
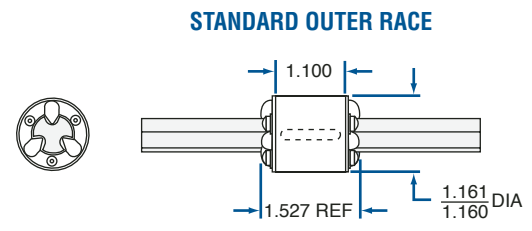

Dotted lines indicate optional keyway

END MACHINING

End Machining for pre-designed or custom prints available.



See page 212 for complete dimensions.

<h1>0625-3-0187 and 0625-6-0187</h1> <p> 0.625 Nominal Size 0.425 Root Diameter 0.187 Nominal Ball Diameter 1.4 Inner Race Weight (lbs./ft.) SOR Stamped Ball Returns HPR Cast Ball Returns </p>	Ball Spline Inner Race Length	PART NUMBERS
	4 FT.	SRR7548
	Custom lengths available up to 4'.	

SOR and HPR Ball Spline Outer Races 60 bearing balls total per 3 circuit outer race, 120 per 6 circuit outer race

PRODUCT SPECIFICATIONS	STANDARD		HIGH PERFORMANCE	
	3	6	3	6
Active Circuits	3	6	3	6
Dynamic Torque (in.-lb.)	585	1,770	585	1,770
Static Torque (in.-lb.)	1,770	3,540	1,770	3,540
Optional Keyway	$\frac{1}{4} \times \frac{1}{8} \times 1.125$	$\frac{1}{4} \times \frac{1}{8} \times 1.125$	$\frac{1}{4} \times \frac{1}{8} \times 1.125$	$\frac{1}{4} \times \frac{1}{8} \times 1.125$
Outer Race Weight (lbs.)	0.82	0.84	0.96	0.98
Outer Race Part Number	SOR7445	SOR8943	HPR7445	HPR8943

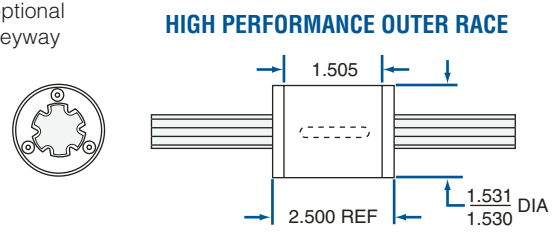
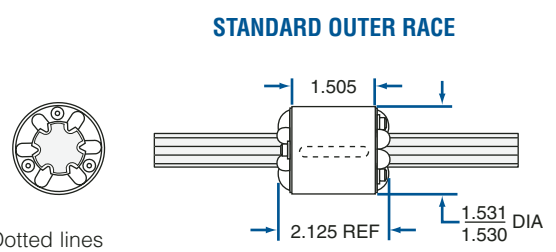

Dotted lines indicate optional keyway

**EZZE-MOUNT™
END BEARING SUPPORTS**

A convenient solution for mounting ball splines.

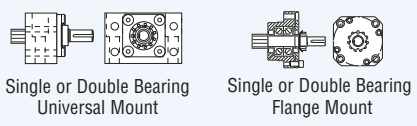

See page 214 for complete dimensions.

END MACHINING

End Machining for pre-designed or custom prints available.

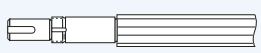

See page 212 for complete dimensions.

1000-3-0187 and 1000-6-0187

- 1.000** Nominal Size
- 0.800** Root Diameter
- 0.187** Nominal Ball Diameter
- 2.2** Inner Race Weight (lbs./ft.)
- SOR** Stamped Ball Returns
- HPR** Cast Ball Returns

Ball Spline Inner Race Lengths	PART NUMBERS
4 FT.	SRR6068
8 FT.	SRR6076
12 FT.	SRR6084
Custom lengths available up to 12'.	

SOR and HPR Ball Spline Outer Races

78 bearing balls total per 3 circuit outer race, 156 per 6 circuit outer race

PRODUCT SPECIFICATIONS	STANDARD		HIGH PERFORMANCE	
	3	6	3	6
Active Circuits	3	6	3	6
Dynamic Torque (in.-lb.)	1,300	2,600	1,300	2,600
Static Torque (in.-lb.)	3,900	7,800	3,900	7,800
Optional Keyway	$\frac{1}{4} \times \frac{1}{8} \times 1.625$	$\frac{1}{4} \times \frac{1}{8} \times 1.625$	$\frac{1}{4} \times \frac{1}{8} \times 1.625$	$\frac{1}{4} \times \frac{1}{8} \times 1.625$
Outer Race Weight (lbs.)	1.21	1.26	1.42	1.48
Outer Race Number	SOR7472	SOR8944	HPR7472	HPR8944

EZZE-MOUNT™ END BEARING SUPPORTS

A convenient solution for mounting ball splines.

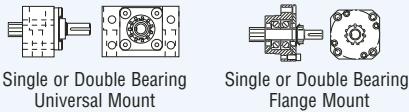

See page 214 for complete dimensions.

END MACHINING

End Machining for pre-designed or custom prints available.



See page 212 for complete dimensions.

STANDARD OUTER RACE

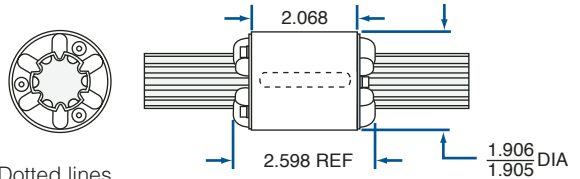

Dotted lines indicate optional keyway

HIGH PERFORMANCE OUTER RACE

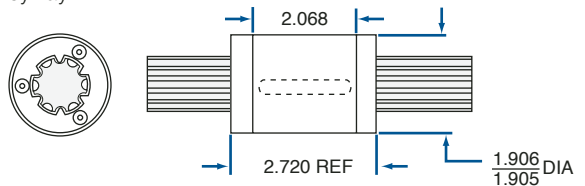

1500-3-0250 and 1500-6-0250

- 1.500** Nominal Size
- 1.250** Root Diameter
- 0.250** Nominal Ball Diameter
- 5.25** Inner Race Weight (lbs./ft.)
- SOR** Stamped Ball Returns
- HPR** Cast Ball Returns

Ball Spline Inner Race Lengths	PART NUMBERS
4 FT.	SRR6372
8 FT.	SRR6380
12 FT.	SRR6388
Custom lengths available up to 12'.	

SOR and HPR Ball Spline Outer Races

84 bearing balls total per 3 circuit outer race, 168 per 6 circuit outer race

PRODUCT SPECIFICATIONS	STANDARD		HIGH PERFORMANCE	
	3	6	3	6
Active Circuits	3	6	3	6
Dynamic Torque (in.-lb.)	4,200	8,400	4,200	8,400
Static Torque (in.-lb.)	11,590	23,170	11,590	23,170
Optional Keyway	$\frac{1}{4} \times \frac{1}{8} \times 2.00$	$\frac{3}{8} \times \frac{3}{16} \times 2.00$	$\frac{1}{4} \times \frac{1}{8} \times 2.00$	$\frac{3}{8} \times \frac{3}{16} \times 2.00$
Outer Race Weight (lbs.)	3.38	3.42	3.96	4.00
Outer Race Number	SOR7528	SOR8945	HPR7528	HPR8945

EZZE-MOUNT™ END BEARING SUPPORTS

A convenient solution for mounting ball splines.

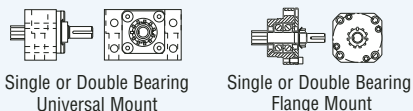

See page 214 for complete dimensions.

END MACHINING

End Machining for pre-designed or custom prints available.



See page 212 for complete dimensions.

STANDARD OUTER RACE

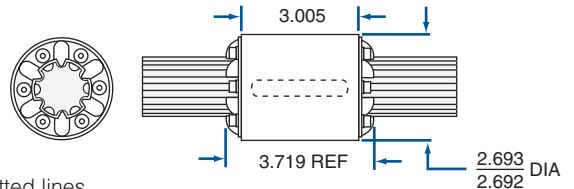

Dotted lines indicate optional keyway

HIGH PERFORMANCE OUTER RACE

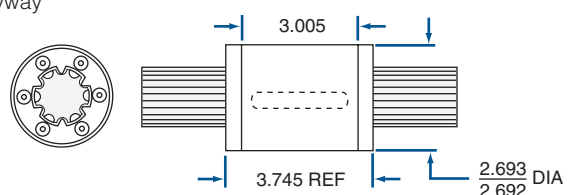

2000-3-0312 and 2000-6-0312

- 2.000** Nominal Size
- 1.670** Root Diameter
- 0.312** Nominal Ball Diameter
- 9.9** Inner Race Weight (lbs./ft.)
- SOR** Stamped Ball Returns
- HPR** Cast Ball Returns

Ball Spline Inner Race Lengths	PART NUMBERS
4 FT.	SRR6420
8 FT.	SRR6428
12 FT.	SRR6436
Custom lengths available up to 12'.	

SOR and HPR Ball Spline Outer Races

72 bearing balls total per 3 circuit outer race, 144 per 6 circuit outer race

PRODUCT SPECIFICATIONS	STANDARD		HIGH PERFORMANCE	
	3	6	3	6
Active Circuits	3	6	3	6
Dynamic Torque (in.-lb.)	8,000	16,000	8,000	16,000
Static Torque (in.-lb.)	20,130	40,270	20,130	40,270
Optional Keyway	$\frac{1}{4} \times \frac{1}{8} \times 2.50$	$\frac{1}{2} \times \frac{7}{32} \times 2.50$	$\frac{1}{4} \times \frac{1}{8} \times 2.50$	$\frac{1}{2} \times \frac{7}{32} \times 2.50$
Outer Race Weight (lbs.)	3.70	3.80	4.40	4.48
Outer Race Number	SOR7530	SOR8946	HPR7530	HPR8946

EZZE-MOUNT™ END BEARING SUPPORTS

A convenient solution for mounting ball splines.

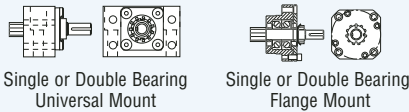

See page 214 for complete dimensions.

END MACHINING

End Machining for pre-designed or custom prints available.



See page 212 for complete dimensions.

STANDARD OUTER RACE

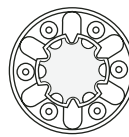

Dotted lines indicate optional keyway

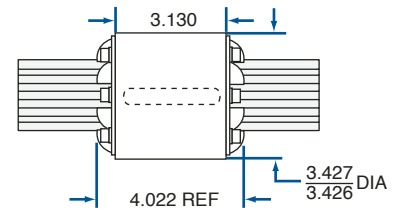

HIGH PERFORMANCE OUTER RACE

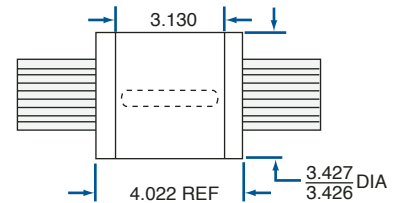
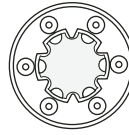

2500-3-0375 and 2500-6-0375

- 2.500** Nominal Size
- 2.10** Root Diameter
- 0.375** Nominal Ball Diameter
- 15.8** Inner Race Weight (lbs./ft.)
- SOR** Stamped Ball Returns
- HPR** Cast Ball Returns

Ball Spline Inner Race Lengths	PART NUMBERS
4 FT.	SRR6468
8 FT.	SRR6476
12 FT.	SRR6484
Custom lengths available up to 12'.	

SOR and HPR Ball Spline Outer Races

66 bearing balls total per 3 circuit outer race, 132 per 6 circuit outer race

PRODUCT SPECIFICATIONS	STANDARD		HIGH PERFORMANCE	
	3	6	3	6
Active Circuits	3	6	3	6
Dynamic Torque (in.-lb.)	18,500	27,000	18,500	27,000
Static Torque (in.-lb.)	32,620	62,250	32,620	62,250
Optional Keyway	$\frac{1}{4} \times \frac{1}{8} \times 3.000$	$\frac{1}{2} \times \frac{1}{4} \times 3.000$	$\frac{1}{4} \times \frac{1}{8} \times 3.000$	$\frac{1}{2} \times \frac{1}{4} \times 3.000$
Outer Race Weight (lbs.)	5.60	5.64	6.50	6.60
Outer Race Number	SOR7532	SOR8947	HPR7532	HPR8947

EZZE-MOUNT™ END BEARING SUPPORTS

A convenient solution for mounting ball splines.

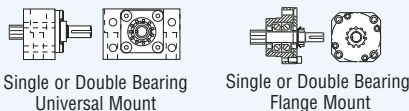

See page 214 for complete dimensions.

END MACHINING

End Machining for pre-designed or custom prints available.



See page 212 for complete dimensions.

STANDARD OUTER RACE

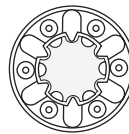

Dotted lines indicate optional keyway

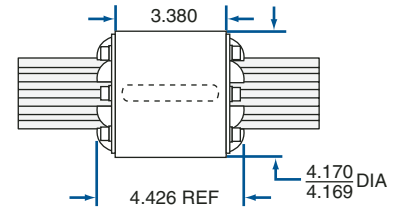

HIGH PERFORMANCE OUTER RACE

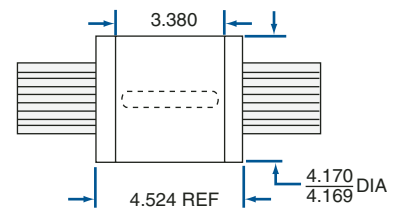
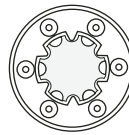

4062-6-0375

- 4.062** Nominal Size
- 3.660** Root Diameter
- 0.375** Nominal Ball Diameter
- 34.4** Inner Race Weight (lbs./ft.)
- SOR** Cast Ball Returns

Ball Spline Inner Race Lengths	PART NUMBERS
4 FT.	SRR8430
8 FT.	SRR8438
12 FT.	SRR2204
Custom lengths available up to 12'.	

SOR Ball Spline Outer Race

180 bearing balls total per outer race

PRODUCT SPECIFICATIONS	STANDARD
Active Circuits	6
Dynamic Torque (in.-lb.)	57,000
Static Torque (in.-lb.)	140,000
Optional Keyway	1 x 1/2 x 3.50
Outer Race Weight (lbs.)	16.00
Outer Race Number	SOR8330

END MACHINING

End Machining for pre-designed or custom prints available.



See page 212 for complete dimensions.

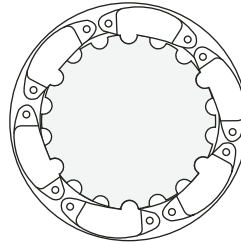

STANDARD OUTER RACE

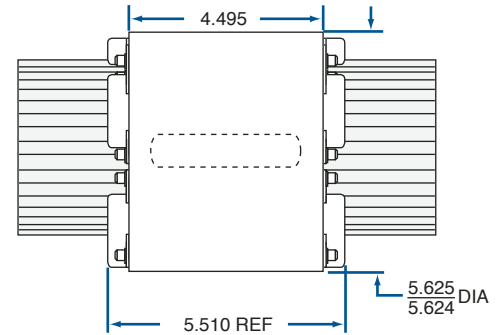

Dotted lines indicate optional keyway

6000-8-0500

- 6.000** Nominal Size
- 5.470** Root Diameter
- 0.500** Nominal Ball Diameter
- 65.0** Inner Race Weight (lbs./ft.)
- SOR** Cast Ball Returns

Ball Spline Inner Race Lengths	PART NUMBERS
6 FT.	SRR4982
Custom lengths available up to 6'.	

SOR Ball Spline Outer Race

224 bearing balls total per outer race

PRODUCT SPECIFICATIONS	STANDARD
Active Circuits	8
Dynamic Torque (in.-lb.)	214,700
Static Torque (in.-lb.)	584,000
Optional Keyway	1 x 1/2 x 5.50
Outer Race Weight (lbs.)	51.00
Outer Race Number	SOR4798

END MACHINING

End Machining for pre-designed or custom prints available.



See page 212 for complete dimensions.

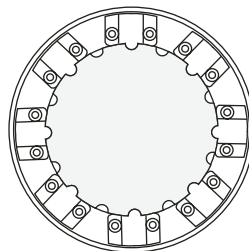

STANDARD OUTER RACE

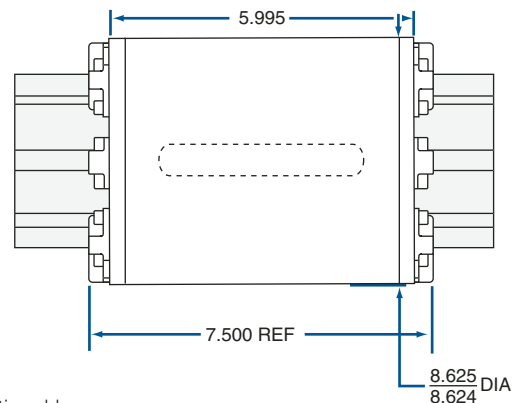

Dotted lines indicate optional keyway